

CHT0670 T-Shaped Hood

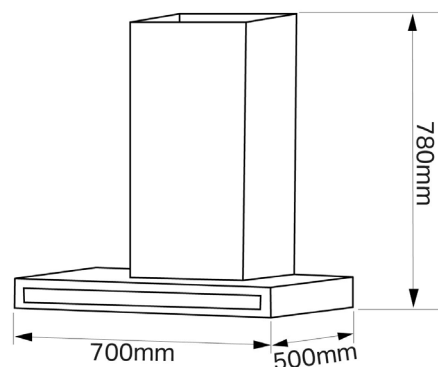

Specification

3 Speed Motor
2 x 1.5w LED Lamps
Electronic Touch Controls

2x Aluminium Filters Inc.
1 Charcoal Filter Inc.
Re-Circulated or Vented

Controls	Touch Controls
Noise Level	62dB (max)
Motor Power	100W
Max Air Flow	550m ³ /h
Energy Consumption	-
Features	Reducer Diameter - 150-120mm
Colour	Stainless Steel
Dimensions	H780 W700 D500mm
Gross Weight	15/17kg
Guarantee	2 Year Parts and Labour Guarantee