

Montpellier

THE PERFECT BALANCE OF FUNCTION AND STYLE

LAUNDRY - DISHWASHING - COOKING - COOLING

Installation and Operating Instructions

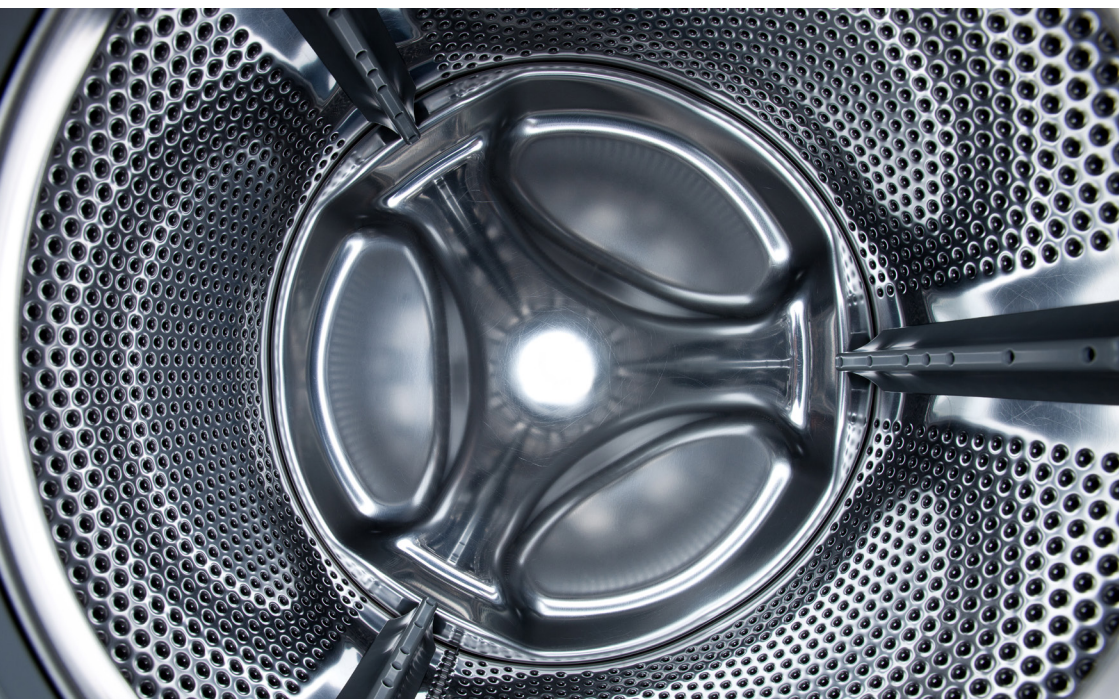

Freestanding Washing Machine

MW6121W - White - 6kg - 1200RPM

Please read these instructions carefully before attempting to install or use this appliance.
We recommend that you keep these instructions in a safe place for future reference.

Welcome

Thank you for choosing this Montpellier Washing Machine.

Our Washers have been designed to provide you with the best combination of style, reliability and performance to give you years of trouble-free use.

You may be familiar with a similar product, but please take time to read these instructions carefully before installing or using your Washer to ensure you get the most from your purchase.

We recommend that you keep this manual in a safe place for future reference.

Your Washing Machine is covered by a comprehensive two year parts & labour guarantee. In the unlikely event that you experience a problem with your Washer, you can rest assured that you are fully protected against the cost of repairs for the first 24 months. Please note that any claim must be accompanied by the model reference number, serial number and proof of purchase.

To activate your guarantee, you will need your product serial number. This can be found on the rear of the machine.

There are two ways to register your Guarantee:

- **Online:** Visit the Support page on our website and complete the online Product Registration form. www.montpellier-appliances.com
- **By Post:** Simply detach and fill in the form provided, attach a stamp and send it in the post. Don't forget to include your e-mail address so that we can send confirmation through to you.



Note: We are unable to take registrations over the phone.

2
YEAR
GUARANTEE
— PARTS & LABOUR —
ACROSS ALL OUR MODELS
Montpellier
www.montpellier-appliances.com

CONTENTS

SAFETY INSTRUCTIONS

■ Safety Instructions	2
-----------------------------	---

INSTALLATION

■ Product Description	7
■ Installation	8

OPERATIONS

■ Quick Start	11
■ Before Each Washing	12
■ Detergent Dispenser	13
■ Control Panel	15
■ Option.....	17
■ Other Functions	18
■ Programmes.....	20
■ Washing Programmes Table	21

MAINTENANCES

■ Cleaning And Care	26
■ Trouble Shooting	29
■ Technical Specifications	31
■ Product Fiches	32

SAFETY INSTRUCTIONS

■ Safety Instructions

For your safety, the information in this manual must be followed to minimize the risk of fire or explosion, electric shock, or to prevent property damage, personal injury or loss of life.

Explanation of the symbols:

Warning!

This combination of symbol and signal word indicates a potentially dangerous situation which may result in death or serious injuries unless it's avoided.

Caution!

This combination of symbol and signal word indicates a potentially dangerous situation which may result in slight or minor injuries or damage to property and the environment.

Note!

This combination of symbol and signal word indicates a potentially dangerous situation which may result in slight or minor injuries.

Warning!

The electric shock!

- If the supply cord is damaged, it must be replaced by the manufacturer, its service agent or similarly qualified persons in order to avoid a hazard.

SAFETY INSTRUCTIONS

- The new hose-sets supplied with the appliance are to be used and that old hose-sets should not be reused.
- Before any maintenance the device, unplug the appliance from the mains.
- Always unplug the machine and turn off the water supply after use. The max. inlet water pressure, in pascals. The min. inlet water pressure, in pascals.
- To ensure your safety, power plug must be inserted into an earthed three-pole socket. Check carefully and make sure that your socket is properly and reliably earthed.
- Make sure that the water and electrical devices must be connected by a qualified technician in accordance with the manufacturer's instructions and local safety regulations.

Risk to children!

- EN countries: the appliance can be used by children aged from 8 years and above and persons with reduced physical, sensory or mental capabilities or lack of experience and knowledge if they have been given supervision or instruction concerning use of the appliance in a safe way and understand the hazards involved. Children shall not play with the appliance. Cleaning and user maintenance shall not be made by children without supervision.
- Children of less than 3 years should be supervised to ensure that they do not play with appliance.
- Animals and children may climb into the machine. Check the machine before every operation.
- Kids should be supervised that they do not play with the appliance.

SAFETY INSTRUCTIONS

- Glass door may be very hot during the operation. Keep kids and pets far away from the machine during the operation very wet rooms as well as in the rooms with explosive or caustic gas.
- Remove all packages and transport bolts before using the appliance. Otherwise, serious damage may result.
- Plug must be accessible after installation.

Risk of explosion!

- Do not wash or dry articles that have been cleaned in, washed in, soaked in, or dabbed with combustible or explosive substances(such as wax, oil, paint, gasoline, degreasers, dry-cleaning solvents, kerosene, etc.) This may result in fire or explosion.
- Before hand thoroughly rinse items of washing by hand.

⚠ Caution!

Installing the product!

- This washing machine is for indoor use only.
- It isn't intended to be built-in using.
- The openings must not be obstructed by a carpet.
- Washing machine shall not be installed in bath room or very wet rooms as well as in the rooms with explosive or caustic gases.
- The washing machine with single inlet valve only can be connected to the cold water supply. The product with double inlet valves should be correctly connected to the hot water and cold water supply.
- Plug must be accessible after installation.

SAFETY INSTRUCTIONS

- Remove all packages and transport bolts before using the appliance. Otherwise, serious damage may result.

Risk of damaging appliance!

- Your product is only for home use and is only designed for the textiles suitable for machine washing.
- Do not climb up and sit on top cover of the machine.
- Do not lean against machine door.
- Cautions during Handling Machine:
 - 1.Transport bolts shall be reinstalled to the machine by a specialized person.
 - 2.The accumulated water shall be drained out of the machine.
 - 3.Handle the machine carefully. Never hold each protruded part on the machine while lifting. Machine door can not be used as the handle during the conveyance.
 - 4.This appliance is heavy. Transport with care.
- Please do not close the door with excessive forces. If it is found difficult to close the door, please check if the clothes are put in or distributed well.
- It is forbidden to wash carpets.

Operating the appliance!

- Before washing the clothes at first time, the product shall be operated in one round of the whole procedures without the clothes inside.
- Flammable and explosive or toxic solvents are forbidden. Gasoline and alcohol etc. Shall not be used as detergents. Please only select the detergents suitable for machine washing, especially for drum.

SAFETY INSTRUCTIONS

- Make sure that all pockets are emptied. Sharp and rigid items such as coin, brooch, nail, screw or stone etc. may cause serious damages to this machine.
- Please check whether the water inside the drum has been drained before opening its door. Please do not open the door if there is any water visible.
- Be careful of burning when the product drains hot washing water.
- Never refill the water by hand during washing.
- After the program is completed, Please wait for two minutes to open the door.

Packaging/Old appliance



This marking indicates that this product should not be disposed with other household wastes throughout the EU. To prevent possible harm to the environment or human health from uncontrolled waste disposal, recycle it responsibly to promote the sustainable reuse of material resources. To return your used device, please use the collection systems or contact the retailer where the product was purchased. They return and can take this product for environmental safe recycling.

INSTALLATION

■ Product Description

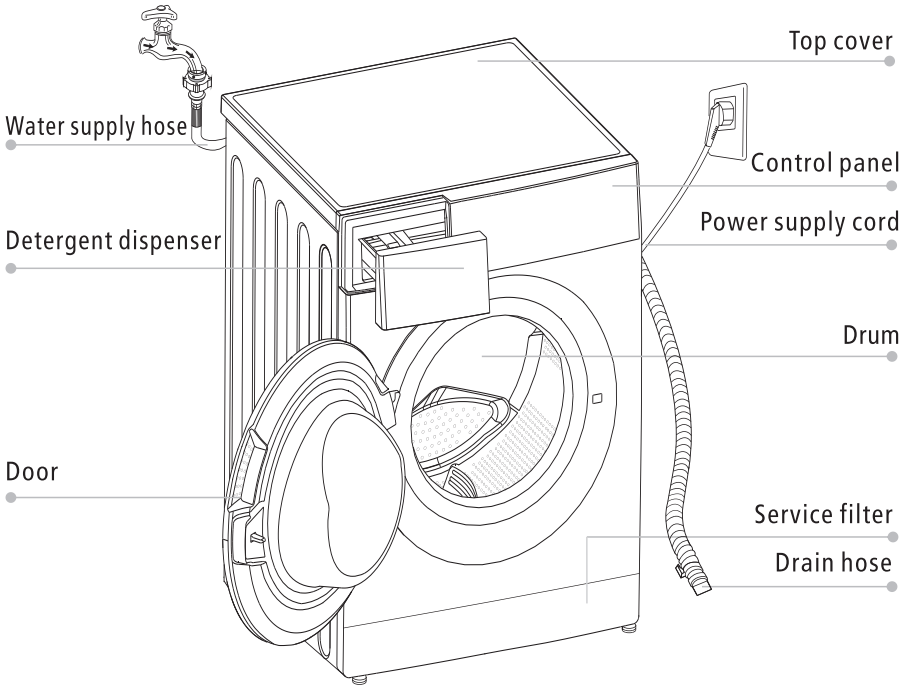

Note!

- The product line chart is for reference only, please refer to real product as standard.

Accessories

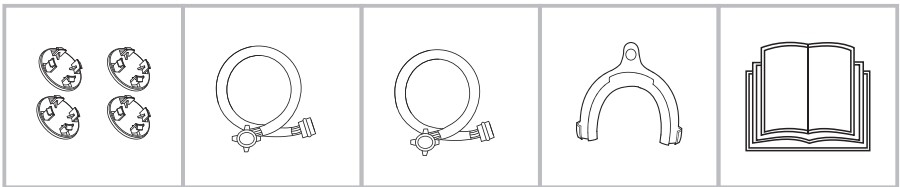

Transport hole plug

Supply hose cold water

Supply hose hot water (optional)

Drain hose support (optional)

Owner's manual

INSTALLATION

■ Installation

Installation area

⚠ Warning!

- Stability is important to prevent the product from wandering!
- Make sure that the product is not stood on the power cord.

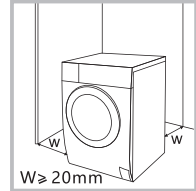

Before installing the machine, the location characterized as follows shall be selected:

1. Rigid, dry, and level surface
2. Avoid direct sunlight
3. Sufficient ventilation
4. Room temperature is above 0°C
5. Keep far away from the heat resources such as coal or gas.

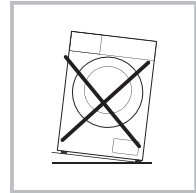

Unpacking the washing machine

⚠ Warning!

- Packaging material (e.g. Films, Styrofoam) can be dangerous for children.
- There is a risk of suffocation ! Keep all packaging well away from children.

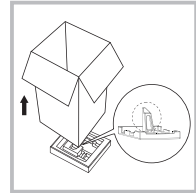

1. Remove the cardboard box and styrofoam packing.
2. Lift the washing machine and remove the base packing. Make sure the small triangle foam is removed with the bottom one together. If not, lay the unit down with side surface, then remove the small foam from the unit bottom manually.
3. Remove the tape securing the power supply cord and drain hose.
4. Remove the inlet hose from the drum.

Remove transport bolts

⚠ Warning!

- You must remove the transport bolts from the backside before using the product.
- You'll need the transport bolts again if you move the product, so make sure you keep them in a safe place.

Please take the following steps to remove the bolts:

1. Loosen 4 bolts with spanner and then remove them.
2. Stop the holes with transport hole plugs.
3. Keep the transport bolts properly for future use.

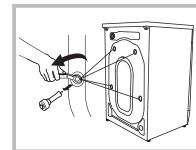

INSTALLATION

Levelling the washing machine

⚠ Warning!

- The lock nuts on all four feet must be screwed tightly against the housing.

1. Check if the legs are closely attached to the cabinet. If not, please turn them to their original positions tighten the nuts.
2. Loosen the lock nut turn the feet until it closely contacts with the floor.
3. Adjust the legs and lock them with a spanner, make sure the machine is steady.

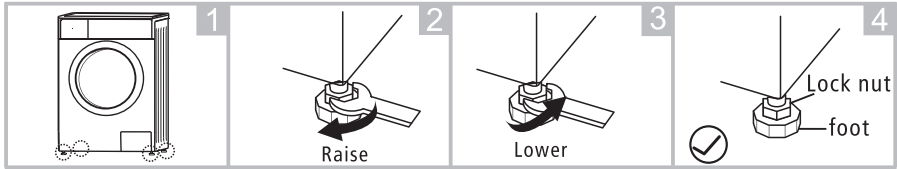

Connect Water Supply Hose

⚠ Warning!

- To prevent leakage or water damage, follow the instructions in this chapter!
- Do not kink, crush, modify or sever water inlet hose.
- For the model equips hot valve, connect it to hot water tap with hot water supply hose. Energy consumption will decrease automatically for some program.

Connect the inlet pipe as indicated, There are two ways to connect the inlet pipe.

1. Connection between ordinary tap and inlet hose.

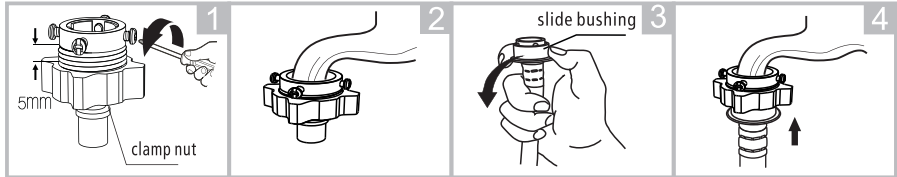

Loosen clamp nut and four bolts

Tighten clamp nut

Press slide bushing, insert inlet hose into connecting base

Connection finished

2. Connection between screw tap and inlet hose.

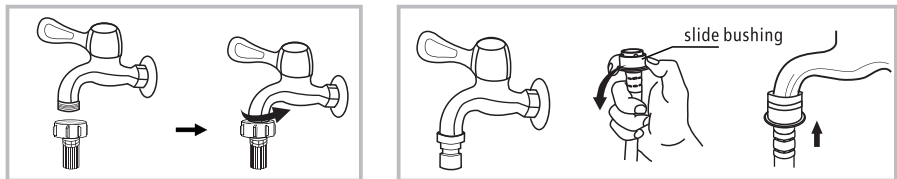

Tap with threads and inlet hose

Special tap for washing machine

INSTALLATION

Connect the other end of inlet pipe to the inlet valve at the backside of product and fasten the pipe tightly clockwise.

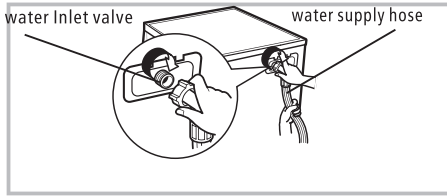

Water Inlet Hose Connection

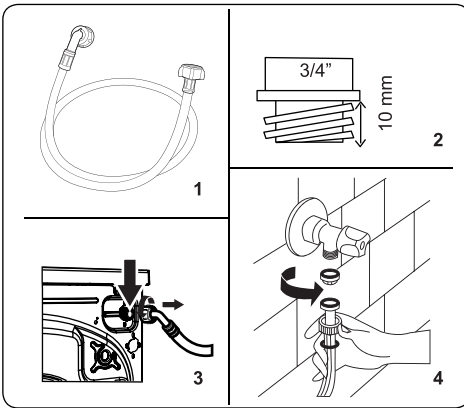

1. Your machine may have either a single water inlet connection (cold) or double water inlet connection (hot and cold) depending on the machine specifications. The white capped hose should be connected to cold water inlet and red capped hose to the hot water inlet (if applicable).

- To prevent water leaks at the joints, either 1 or 2 nuts (depending on your machine's specifications) are supplied in the packaging with the hose. Fit these nuts to the end(s) of the water inlet hose that connect to the water supply.
2. Connect new water inlet hoses to a $\frac{3}{4}$ " threaded tap.
 - Connect the white capped end of the water inlet hose to the white water inlet valve on the rear side of the machine and the red capped end of the hose to the red water inlet valve (if applicable).
 - Hand tighten the connections. If in any doubt, consult a qualified plumber.
 - Water flow with pressure of 0.1-1 Mpa will allow your machine to operate at optimum efficiency (pressure of 0.1 Mpa means that more than 8 litres of water per minute will flow through a fully opened tap).
3. Once you have made all of the connections, carefully turn the water supply on and check for leaks.
 4. Ensure that the new water inlet hoses are not bent, broken, crushed or resized.
 - If your machine has a hot water inlet connection, the temperature of the hot water supply should not be higher than 70°C.



NOTE: Your Washing Machine must only be connected to your water supply using the supplied new fill hose. Old hoses must not be reused.

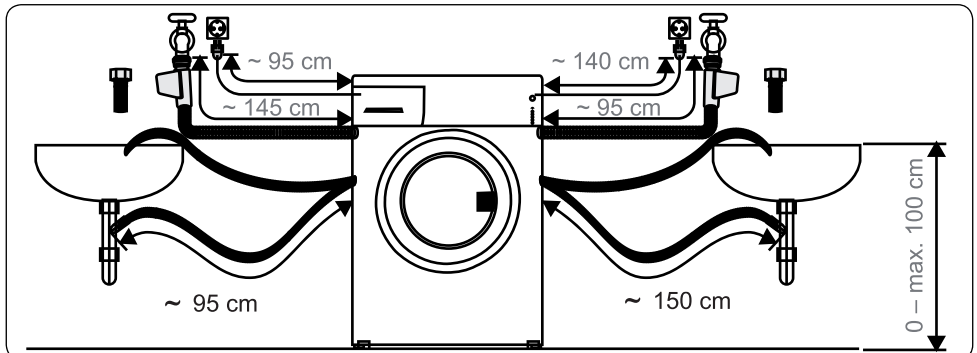

OPERATIONS

■ Quick Start

⚠ Caution!

- Before washing, please make sure it's installed properly.
- Before washing at first time, the washing machine shall be operated in one round of the whole procedures without clothes in as follows.

1. Before Washing

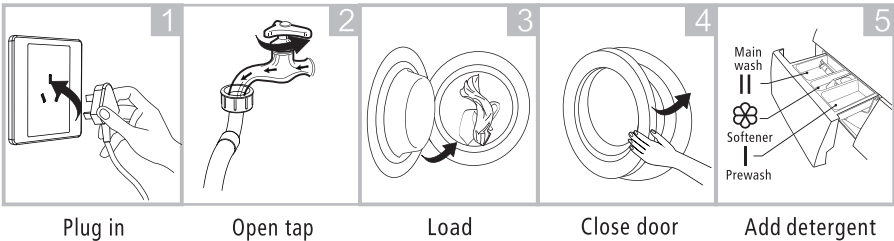

📌 Note!

- Detergent need to be added in "case I" after selecting pre-washing for machines with this function.

2. Washing

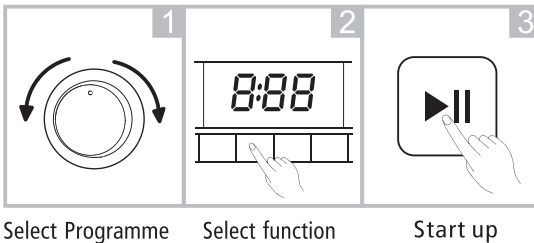

3. After Washing

"End" on display.

OPERATIONS

■ Before Each Wash

- The working condition of the washer should be (0-40)°C. If used under 0°C, the inlet valve and draining system may be damaged. If the machine is placed under condition of 0°C or less, then it should be transferred to normal ambient temperature to ensure the water supply hose and drain hose are not frozen before use.
- Please check the labels and the explanation of using detergent before wash. Use non-foaming or less-foaming detergent suitable for machine washing properly.

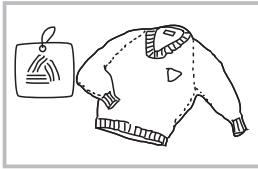

Check the label

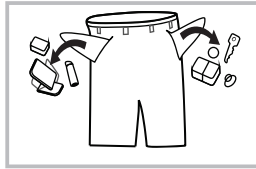

Take out the items out of the pockets

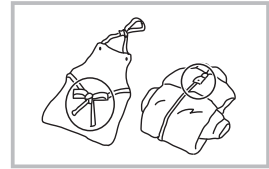

Knot the long strips, zip or button

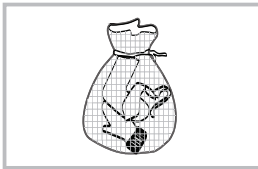

Put small clothes into the pillow slip

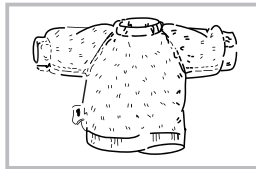

Turn easy-pilling and long-pile fabric inside out

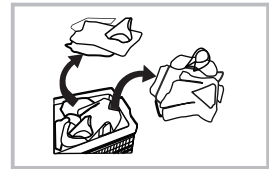

Separate clothes with different textures

⚠ Warning!

- When washing single items, it may easily cause great eccentricity and may effect your machine due to unbalance. Therefore, it is suggested to add 1 or 2 more items to be washed together so that spin/draining can be done smoothly.
- Don't wash items of clothing which have come into contact with kerosene, gasoline, alcohol and other flammable materials.

OPERATIONS

■ Detergent Dispenser

- I Prewash detergent
- II Main wash detergent
- ☼ Softener

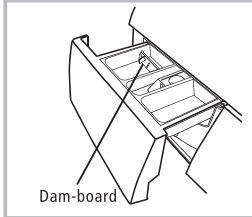

Liquid detergent

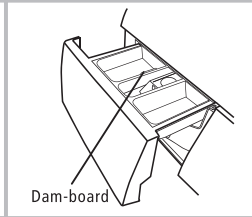

Powder detergent

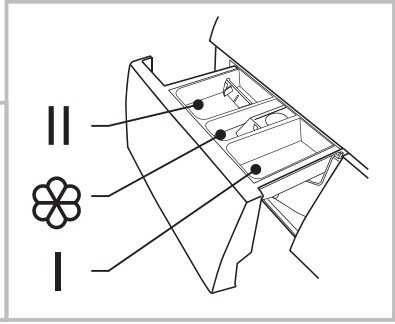

Pull out the dispenser

⚠ Caution!

- Detergent only need to be added in "case I " after selecting pre-washing for machines with this function.

Model: MW6121W

Programme	I	II	☼	Programme	I	II	☼
Cotton Eco 40 °C		●	○	Spin Only			
Cotton Eco 60 °C		●	○	Drain Only			
Cotton	○	●	○	Rinse&Spin			○
Cotton 20 °C	○	●	○	Delicate 30 °C		●	○
Cotton 30 °C	○	●	○	Delicate		●	○
Cotton 40 °C	○	●	○	Ends in 9H		●	○
Cotton 60 °C	○	●	○	Ends in 6H		●	○
Cotton 90 °C	○	●	○	Ends in 3H		●	○
Synthetic	○	●	○	Daily Wash 45'		●	○
Synthetic 40 °C	○	●	○	Daily Wash 30'		●	○
Synthetic 60 °C	○	●	○	Daily Wash 15'		●	○
Drum Clean							

● Means must ○ Means optional

OPERATIONS

■ Control Panel

Model: MW6121W

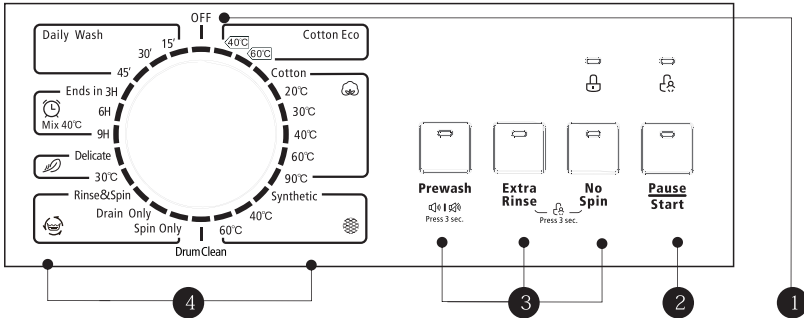

📌 Note!

- If using liquid detergent, before you pour it into the detergent box, it is suggested to use some water for dilution to prevent the inlets of the detergent box from being blocked and overflowing whilst filling with water.
- Please choose suitable type of detergent for the various washing temperature to get the best washing performance with less water and energy consumption.

1 Off

Product is switched off.

2 Start / Pause

Press the button to start or pause the washing cycle.

3 Option

This allows you to select an additional function and will light when selected.

4 Programmes

Available according to the laundry type.

OPERATIONS

■ Option

Prewash: The Prewash function can get an extra wash before main wash, it is suitable for washing the dust rises to surface of the clothes; You need to put detergent into the Case (I) when select it.

Extra Rinse: The laundry will undergo extra rinse once after you select it.

No Spin: It will not spin if you choose this function.

Delay: Delay function can be set with this button, the delaying time is 0-24H.

Spin Speed: Adjustable spin speed (programme dependant)

Model: MW6121W

Programme	Option		Programme	Option	
	Prewash	Extra Rinse		Prewash	Extra Rinse
Cotton Eco 40 °C			Drain Only		
Cotton Eco 60 °C			Rinse&Spin		○
Cotton/Normal	○	○	Delicate 30 °C		○
Cotton/Normal 20 °C	○	○	Delicate		○
Cotton/Normal 30 °C	○	○	Ends in 9H		
Cotton/Normal 40 °C	○	○	Ends in 6H		
Cotton/Normal 60 °C	○	○	Ends in 3H		
Cotton/Normal 90 °C	○	○	Daily Wash 45'		
Synthetic	○	○	Daily Wash 30'		
Synthetic 40 °C	○	○	Daily Wash 15'		
Synthetic 60 °C	○	○	Spin Only		
Drum Clean					
Spin Only					

○ Means optional

OPERATIONS



Child Lock

To avoid mis operation by children.



Choose the Programme

Start

Press [Extra Rinse] and [No Spin]/ [Spin Speed] 3 sec. till buzzer beep.

⚠ Caution!

- Press the two buttons for 3sec to remove the child lock.
- The Child lock will lock all buttons except the power button.
- The Child lock could remain active if power is lost to the machine.

Temp.

The temperature is range is as follows: Cold, 20°C, 30°C, 40°C, 60°C, 90°C

Speed

The speed is:

1200-0-400-600-800-1000-1200

Programme	Default Speed(rpm)	Programme	Default Speed(rpm)
	1200		1200
Cotton Eco 40 °C	1200	Spin Only	1200
Cotton Eco 60 °C	1200	Drain Only	-
Cotton/Normal	1200	Rinse&Spin	1200
Cotton/Normal 20 °C	1200	Delicate 30 °C	600
Cotton/Normal 30 °C	1200	Delicate	600
Cotton/Normal 40 °C	1200	Ends in 9H/Mix 60 °C	1000
Cotton/Normal 60 °C	1200	Ends in 6H/Mix 40 °C	1000
Cotton/Normal 90 °C	1200	Ends in 3H/Mix	1000
Synthetic	1000	Daily Wash 45'	800
Synthetic 40 °C	1000	Daily Wash 30'	800
Synthetic 60 °C	1000	Daily Wash 15'	800
Drum Clean	400		

OPERATIONS

■ Programmes

Programmes are available according to the laundry type.

Programmes

Cotton/Normal	Hard-wearing textiles, heat-resistant textiles made of cotton or linen.
Synthetic	Wash synthetic articles, for example: shirts, coats, blending. While washing the knitting textiles, detergent quantity shall be reduced due to its loose string construction and easily forming bubbles.
Daily Wash	It is suitable for washing few and not very dirty clothes quickly.
Cotton Eco	To increase the washing performance, washing time is increased.
Ends in	The function can be set with this programme, the total time including washing time and delaying time is 3h, 6h or 9h.
Delicate	For delicate, washable textiles, e.g. made of silk, satin, synthetic fibres or blended fabrics.
Drum Clean	Special programme which cleans the drum and tube. It applies 90 °C high temperature sterilization to keep your appliance clean and efficient. When this programme is performed, the clothes or other washing cannot be added. When the correct detergent containing a chlorine bleaching agent is put in, the barrel cleaning effect will be better. The customer can use this programme regularly according to their needs.
Spin Only	Extra spin
Rinse&Spin	Extra rinse with spin.
Drain Only	Drain off the water.
Mix	Mixed load consisting of textiles made of cotton and synthetics.

OPERATIONS

■ Washing Programmes Table

Model: MW6121W

Programme	Load(kg)	Temp.(°C)	Default Time
	6.0	Default	6.0
			1200
Cotton Eco 40 °C	6.0	40	3:45
Cotton Eco 60 °C	6.0	60	3:19
Cotton	6.0	Cold	1:35
Cotton 20 °C	6.0	20	1:19
Cotton 30 °C	6.0	30	1:20
Cotton 40 °C	6.0	40	1:40
Cotton 60 °C	6.0	60	1:45
Cotton 90 °C	6.0	90	2:40
Synthetic	3.0	Cold	1:18
Synthetic 40 °C	3.0	40	1:33
Synthetic 60 °C	3.0	60	1:43
Drum Clean	-	90	1:21
Spin Only	6.0	-	0:12
Drain Only	-	-	0:01
Rinse&Spin	6.0	-	0:31
Delicate 30 °C	2.5	30	1:00
Delicate	2.5	Cold	0:55
Ends in 9H	6.0	40	1:13
Ends in 6H	6.0	40	1:13
Ends in 3H	6.0	40	1:13
Daily Wash 45'	2.0	30	0:45
Daily Wash 30'	2.0	20	0:30
Daily Wash 15'	2.0	Cold	0:15

- **The EU energy efficiency class is A++ for 6kg(50Hz)**

Energy test program: Cotton Eco 60°C/40°C. Speed: the highest speed; Other as the default.

Half load for 6.0Kg machine:3.0Kg.

"Cotton Eco 60°C/40°C " is the standard washing programs to which the information in the label and the fiche relates, and they are suitable to clean normally soiled cotton laundry and that they are the most efficient programmes in terms of combined energy and water consumptions for washing that type of cotton laundry, that the actual water temperature may differ from the declared cycle temperature.

- **The AR energy efficiency class is A**

Energy test program: Cotton ECO 40°C. Speed: the highest speed; Other as the default.

Note!

- The parameters in this table are only for user's reference. The actual parameters may be different with the parameters in above mentioned table.

MAINTENANCES

■ Cleaning And Care

Warning!

- Before your maintenance starts, please unplug the machine and close the tap.

Cleaning The Cabinet

Proper maintenance on the washing machine can extend its working life. The surface can be cleaned with diluted non-abrasive neutral detergents when necessary. If there is any water overflow, use the wet cloth to wipe it off immediately. No sharp items are allowed.

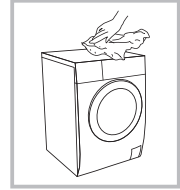

Note!

- Formic acid and its diluted solvents or equivalent are forbidden, such as alcohol, solvents or chemical products, etc. All cleaning should be done with a soft 'cloth like an E-Cloth

Note!

- Don't put laundry in the washing machine during the drum cleaning.

Cleaning The Door Seal And Glass

Wipe the glass and seal after each wash to remove lint and stains. If lint builds up it can cause leaks. Remove any coins, buttons and other objects from the seal after each wash.

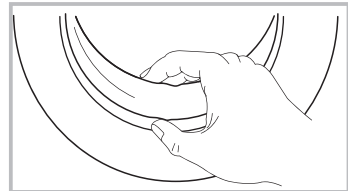

MAINTENANCES

Cleaning The Inlet Filter

Note!

- Inlet filter must be cleaned if there is a drop in water pressure

Washing the filter in the tap

1. Close the tap.
2. Remove the water supply hose from the tap.
3. Clean the filter.
4. Reconnect the water supply hose.

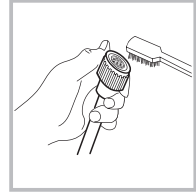
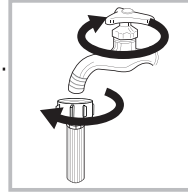

Note!

- If the brush does not clean the filter (as in above diagram), you can pull out the filter wash separately;
- Reconnect, turn on the tap.

Clean The Detergent Dispenser

1. Press down the arrow location on softener cover inside the dispenser drawer.
2. Lift the clip up and take out softener cover and wash all grooves with water.
3. Restore the softener cover and push the drawer into position.

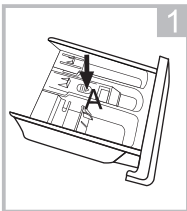

Pull out the dispenser drawer with press the A

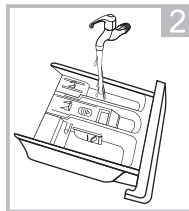

Clean the dispenser drawer under water

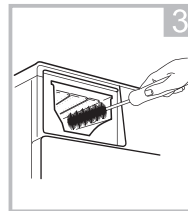

Clean inside the recess with an old toothbrush

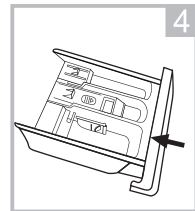

Insert the dispenser drawer

Note!

- Do not use alcohol, solvents or chemical products to clean the machine.

MAINTENANCES

Cleaning The Drain Pump Filter

⚠ Warning!

- Be careful of the hot water!
- Allow detergent solution to cool down.
- Unplug the machine to avoid electrical shock before washing.
- Drain pump filter can filter the yarns and small foreign matters from the washing.
- Clean the filter periodically to ensure the normal operation of washing machine.

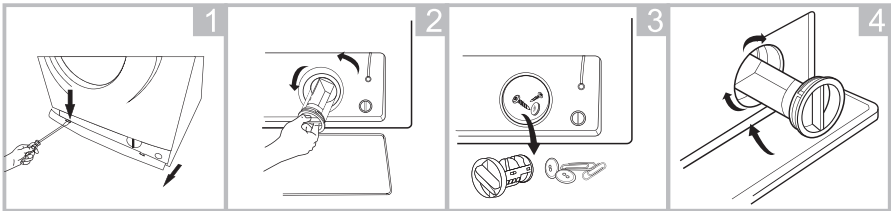

Open the Service filter

Open the filter by turning to the counter clockwise

Remove extraneous matter

Close the lower cover cap

⚠ Caution!

- Make sure that valve cap and emergency drain hose are reinstalled properly, cap plates should be inserted aligning to hole plates otherwise water may leak.
- Some machines don't have emergency drain hose, so step 2 and step 3 can be skipped. Rotate filter counter clockwise to start the flow of water into basin.
- When the appliance is in use and depending on the programme selected there can be hot water in the pump. Never remove the pump cover during a wash cycle, always wait until the appliance has finished the cycle, and is empty. When replacing the cover, ensure it is securely re-tightened.

MAINTENANCES

■ Trouble Shooting

The start of the appliance does not work or it stops during operation. First try to find a solution to the problem, If not, contact the service centre.

Description	Reason	Solution
Washing machine cannot start up	Door is not closed properly	Restart after the door is closed Check if the clothes is stuck
Door can't be opened	Washer's safety protection design is working	Disconnect the power, restart the product
Water leakage	The connection between inlet pipe or outlet hose is not tight	Check and fasten water pipes Clean up outlet hose
Detergent residues in the box	Detergent is dampened or agglomerated	Clean and wipe the detergent box
Indicator or display does not light	Disconnect the power PC board or harness has connection problem	Check if the power is shut down and the power plug is connected correctly
Abnormal noise		Check if the fixing (bolts) have been removed Check it's installed on a solid and level floor

Description	Reason	Solution
Flash Off	Door is not closed properly	Restart after the door is closed Check if the clothes is stuck
Off		
Flash Off	Water injecting problem while washing	Check if the water pressure is too low Straighten the water pipe Check if the inlet valve filter is blocked
Off		
Flash Off	Overtime water draining	Check if the drain hose is blocked
Off		
Flash Off	Water overflow	Restart the washer
Off		
	Others	Please try again first, call up service line if there are still troubles

MAINTENANCES

Description	Reason	Solution
E30	Door is not closed properly	Restart after the door is closed Check if the clothes is stuck
E10	Water injecting problem while washing	Check if the water pressure is too low Straighten the water pipe Check if the inlet valve filter is blocked
E21	Overtime water draining	Check if the drain hose is blocked
E12	Water overflow	Restart the washer
Others	Please try again first, call up service line if there are still troubles	



Note!

- After the check, activate the appliance. If the problem occurs again, contact the service provider on **01759 487839**

MAINTENANCES

■ Technical Specifications

Power Supply	220-240V~,50Hz
MAX.Current	10A

Standard Water Pressure	0.05MPa~1MPa
-------------------------	--------------

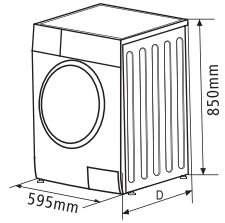

Model	Washing Capacity	Dimension (W*D*Hmm)	Net Weight	Rated Power
MW6121W	6.0kg	595*470*850	54kg	1950W

MAINTENANCES

Product Fiche:		MW6121W
Capacity	①	6kg
Spin Speed	②	1200 rpm
Energy efficiency class		A ++
Annual energy consumption		173kWh /annual
Power consumption of off - mode	③	0.5W
Power consumption of Left on -mode	④	1.0W
Annual water consumption	⑤	9240L /annual
Spin- drying efficiency class		B
Standard washing cycle		Cotton ECO
Energy consumption of the standard 60°C at full load		0.90 kwh /cycle
Energy consumption of the standard 60°C at partial load		0.65 kwh /cycle
Energy consumption of the standard 40° C at partial load		0.62kwh /cycle
Programme duration of standard 60° C at full load		239 min
Programme duration of standard 60°C at partial load		210min
Programme duration of standard 40°C at partial load		204min
Water consumption of the standard 60° C at full load		48L /cycle
Water consumption of standard 60°C at partial load		37L /cycle
Water consumption of the standard 40° C at partial load		37L /cycle
Remaining moisture content of the standard 60°C at full load		50%
Remaining moisture content of the standard 60°C at partial load		55%
Remaining moisture content of the standard 40°C at partial load		55%
Noise level of washing		59dB (A)
Noise level of spinning		76dB (A)

MAINTENANCES

Note!

- Programme setting for testing in accordance with applicable standard En60456.
- When using the test programmes, wash the specified load using the maximum spin speed.
- The actual parameters will depend on how the appliance is used, and maybe different with the parameters in above mentioned table.

Remarks:

- 1 The energy efficiency class is from A(highest efficiency) to D (lowest efficiency).
- 2 Energy consumption per year, based on 220 standard washing cycles for standard programme at 60°C and 40°C at full and partial load, and the consumption of the low-power modes. Actual energy consumption will depend on how the appliance is used.
- 3 Water consumption per year based on 220 standard washing cycles for standard programme at 60°C and 40°C at full and partial load. Actual water consumption will depend on how the appliance is used.
- 4 Spin-drying efficiency class from G (least efficient) to A (most efficient).
- 5 The standard 60°C programme and the standard 40°C programme are the standard washing programmes. These programmes are suitable to clean normally soiled cotton laundry and they are the most efficient programmes in terms of combined energy and water consumptions for washing that type of cotton laundry. The actual water temperature may differ from the declared cycle temperature.
Please choose the suitable type of detergent for the various washing temperatures to get the best washing performance with less water and energy consumption.

Here For You

After-sales assistance

If you continue to experience problems with your Washing Machine, please call the Montpellier customer service helpline on: **01759 487839**

Please have all your product details available, including the model number, serial number, date of purchase, and your retailer's details before registering a fault.

The service call cannot progress without this information.

Your 2 year Manufacturer's guarantee

THIS DOES NOT AFFECT YOUR STATUTORY RIGHTS.

Your new Montpellier appliance carries a free guarantee which protects you against the cost of repairs during the first 24 months from date of purchase provided that:

Any claim is accompanied by evidence of the model reference, model serial number and proof of purchase, such as a Sales Receipt, showing that the appliance was purchased within the 24 months prior to the date of claim.

What is not covered under the Guarantee

- Any appliance not correctly installed and operated in accordance with the manufacturer's instructions.
- Any appliance that is used for anything other than domestic purposes.
- Any defect caused by accident, misuse, unauthorised modification or inexpert repair.
- Cost of Call-out where a fault cannot be found with the appliance.
- Cost of Call-out for work covering routine maintenance, such as, but not exclusively, cleaning of filters or defrosting.
- Cost of Call-out for work required to correct the alignment of doors following door reversal procedures carried out by you.
- Use of the appliance by anyone other than the Householder.
- Use in any commercial environment.
- Consumable items, such as, but not exclusively, fuses in plugs, bulbs and breakable items which require routine replacement.
- Repair costs incurred that have not been authorised by Montpellier service and/or carried out by a non-approved Montpellier engineer.
- Montpellier Appliances do not accept claims for consequential loss, rusting, corroding, delivery damage or scratches.

YOUR GUARANTEE IS VALID ONLY IN THE UK.

To register your appliance simply complete the card in your appliance pack and return it with a stamp affixed or alternatively you can register online at **www.montpellier-appliances.com/support**

SERVICE HELP-LINE

Should your appliance develop a fault, please call the Montpellier customer service helpline on: **01759 487839**

Please remember to have all your product details available, including the model number, serial number, date of purchase and your retailer's details before registering a fault.

Montpellier Domestic Appliances Ltd.

Unit 1, Tewkesbury Retail Park, Northway Lane,
Tewkesbury, Gloucestershire GL20 8JU

www.montpellier-appliances.com



The symbol on the product or on its packaging indicates that this product may not be treated as household waste. Instead it shall be handed over to the applicable collection point for the recycling of electrical and electronic equipment. By ensuring this product is disposed of correctly, you will help prevent potential negative consequences for the environment and human health, which could otherwise be caused by inappropriate waste handling of this product. For more detailed information about recycling of this product, please contact your local city office, your household waste disposal service or the shop where you purchased the product.