

Montpellier

THE PERFECT BALANCE OF FUNCTION AND STYLE
LAUNDRY - DISHWASHING - COOKING - COOLING

Installation and Operating Instructions

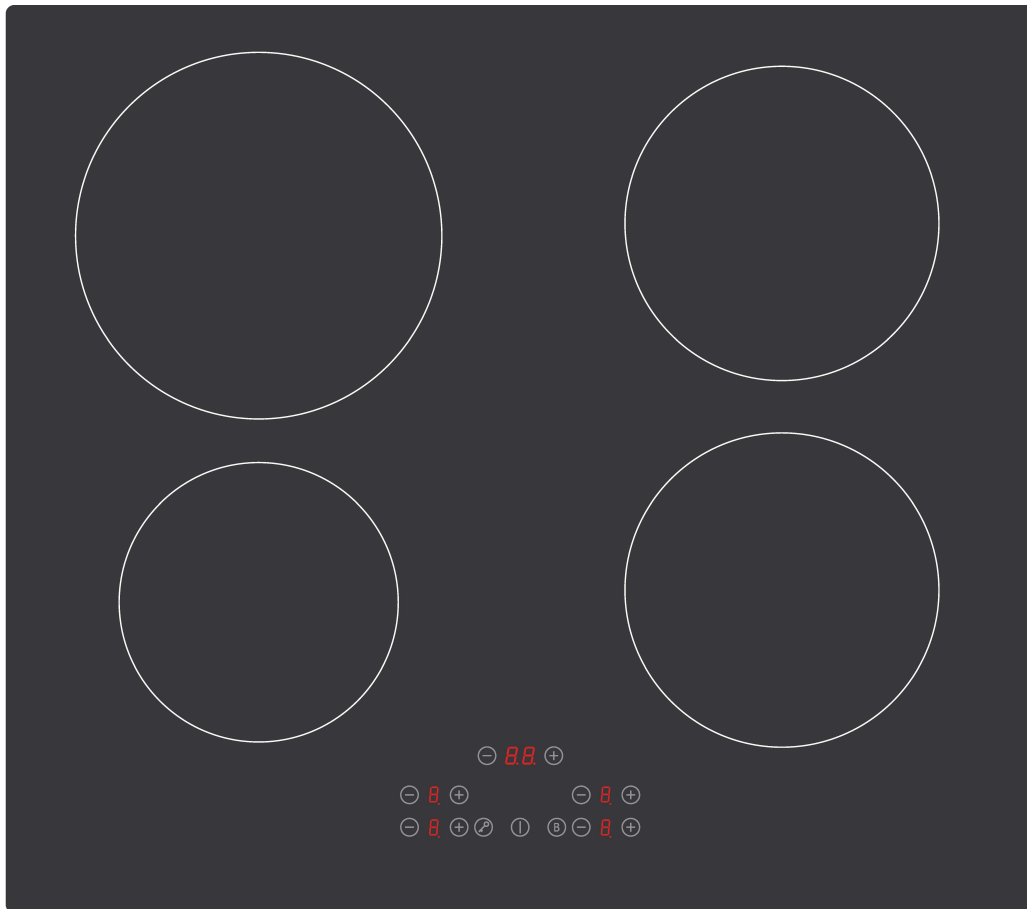

59cm Induction Hob - Touch Control MINH59

Please read these instructions carefully before attempting to install or use this appliance.
We recommend that you keep these instructions in a safe place for future reference.

Welcome

Thank you for choosing this Montpellier appliance.

Our appliances have been designed to provide you with the best combination of style, reliability and performance to give you years of trouble-free use.

You may be familiar with a similar product, but please take time to read these instructions carefully before installing or using your appliance to ensure you get the most from your purchase.



2
YEAR
GUARANTEE
— PARTS & LABOUR —
ACROSS ALL OUR MODELS
Montpellier
www.montpellier-appliances.com

We recommend that you keep this manual in a safe place for future reference.

Your appliance is covered by a comprehensive two year Parts & Labour Guarantee. In the unlikely event that you experience a problem with your appliance, you can rest assured that you are fully protected against the cost of repairs for the first 24 months . Please note that any claim must be accompanied by the model reference number, serial number and proof of purchase.

To activate your guarantee, you will need your product serial number. This can be found inside your appliance.

NB: Please make sure that you keep a copy of your original sales invoice as this will be needed if any service call is required.

There are three ways to register your Guarantee:

- **Online:** Visit the Support page on our website and complete the online Product Registration form. www.montpellier-appliances.com
- **By Post:** Simply detach and fill in the form provided, attach a stamp and send it in the post. Don't forget to include your e-mail address so that we can send confirmation through to you.
- **By Phone:** Contact our warranty registration department on **0808 1961388**

Thank you for choosing this product.

This User Manual contains important safety information and instructions on the operation and maintenance of your appliance.

Please take the time to read this User Manual before using your appliance and keep this book for future reference.

The design and specifications are subject to change without prior notice for product improvement.

THANK YOU LETTER

Thank you for choosing Montpellier! Before using your new Montpellier product, please read this manual thoroughly to ensure that you know how to operate the features and functions that your new appliance offers in a safe way.

CONTENTS

THANK YOU LETTER	1
SAFETY INSTRUCTIONS	2
SPECIFICATIONS	5
PRODUCT INSTALLATION	6
PRODUCT OVERVIEW	12
OPERATION INSTRUCTIONS	14
QUICK START GUIDE	21
CLEANING AND MAINTENANCE	23
TROUBLESHOOTING	24
DISPOSAL AND RECYCLING	28
HERE FOR YOU	29

SAFETY INSTRUCTIONS

Intended Use

The following safety guidelines are intended to prevent unforeseen risks or damage from unsafe or incorrect operation of the appliance. Please check the packaging and appliance on arrival to make sure everything is intact to ensure safe operation. If you find any damage, please contact the retailer or dealer. Please note modifications or alterations to the appliance are not allowed for your safety concern. Unintended use may cause hazards and loss of warranty claims.

SAFETY WARNINGS

Your safety is important to us. Please read this information before using your cooktop.

INSTALLATION

Electrical Shock Hazard

- Disconnect the appliance from the mains electricity supply before carrying out any work or maintenance on it.
- Connection to a good earth wiring system is essential and mandatory.
- Alterations to the domestic wiring system must only be made by a qualified electrician.
- Failure to follow this advice may result in electrical shock or death.

Cut Hazard

- Take care - panel edges are sharp.
- Failure to use caution could result in injury or cuts.

Important Safety Instructions

- Read these instructions carefully before installing or using this appliance.
- No combustible material or products should be placed on this appliance at any time.
- Please make this information available to the person responsible for installing the appliance as it could reduce your installation costs.
- In order to avoid a hazard, this appliance must be installed according to these instructions for installation.
- This appliance is to be properly installed and earthed only by a suitably qualified person.
- This appliance should be connected to a circuit which incorporates an isolating switch providing full disconnection from the power supply.
- Failure to install the appliance correctly could invalidate any warranty or liability claims.
- This appliance can be used by children aged from 8 years and above and persons with reduced physical, sensory or mental capabilities or lack of experience and knowledge if they have been given supervision or instruction concerning use of the appliance in a safe way and understand the hazards involved.

- Children shall not play with the appliance. Cleaning and user maintenance shall not be made by children without supervision.
- If the supply cord is damaged, it must be replaced by the manufacturer, its service agent or similarly qualified persons in order to avoid a hazard.
- **WARNING:** If the surface is cracked, switch off the appliance to avoid the possibility of electric shock, for hob surfaces of glass-ceramic or similar material which protect live parts.
- Metallic objects such as knives, forks, spoons and lids should not be placed on the hob surface since they can get hot.
- A steam cleaner is not to be used.
- Do not use a steam cleaner to clean your cooktop.
- The appliance is not intended to be operated by means of an external timer or separate remote-control system.
- **WARNING:** Danger of fire: do not store items on the cooking surfaces.
- The cooking process has to be supervised. A short term cooking process has to be supervised continuously.
- **WARNING:** Unattended cooking on a hob with fat or oil can be dangerous and may result in fire. NEVER try to extinguish a fire with water, but switch off the appliance and then cover flame e.g. with a lid or a fire blanket.

OPERATION AND MAINTENANCE

Electrical Shock Hazard

- Do not cook on a broken or cracked cooktop. If the cooktop surface should break or crack, switch the appliance off immediately at the mains power supply (wall switch) and contact a qualified technician.
- Switch the cooktop off at the wall before cleaning or maintenance.
- Failure to follow this advice may result in electrical shock or death.

Hot Surface Hazard

- During use, accessible parts of this appliance will become hot enough to cause burns.
- Do not let your body, clothing or any item other than suitable cookware contact the glass until the surface is cool.
- Keep children away.
- Handles of saucepans may be hot to touch. Check saucepan handles do not overhang other cooking zones that are on. Keep handles out of reach of children.
- Failure to follow this advice could result in burns and scalds.

Cut Hazard

- The razor-sharp blade of a cooktop scraper is exposed when the safety cover is retracted. Use with extreme care and always store safely and out of reach of children.
- Failure to use caution could result in injury or cuts.

Health Hazard

- This appliance complies with electromagnetic safety standards.
- However, persons with cardiac pacemakers or other electrical implants (such as insulin pumps) must consult with their doctor or implant manufacturer before using this appliance to make sure that their implants will not be affected by the electromagnetic field.
- Failure to follow this advice may result in death.

Important safety instructions

- Do not place or leave any magnetisable objects (e.g. credit cards, memory cards) or electronic devices (e.g. computers, MP3 players) near the appliance, as they may be affected by its electromagnetic field.
- Never leave the appliance unattended when in use. Boil over causes smoking and greasy spill overs that may ignite.
- Never use your appliance as a work or storage surface.
- Never leave any objects or utensils on the appliance.
- Never use your appliance for warming or heating the room.
- After use, always turn off the cooking zones and the cooktop as described in this manual (i.e. by using the touch controls).
- Do not allow children to play with the appliance or sit, stand, or climb on it.
- Do not store items of interest to children in cabinets above the appliance. Children climbing on the cooktop could be seriously injured.
- Do not leave children alone or unattended in the area where the appliance is in use.
- Children or persons with a disability which limits their ability to use the appliance should have a responsible and competent person to instruct them in its use. The instructor should be satisfied that they can use the appliance without danger to themselves or their surroundings.
- Do not repair or replace any part of the appliance unless specifically recommended in the manual. All other servicing should be done by a qualified technician.
- Do not place or drop heavy objects on your cooktop.
- Do not stand on your cooktop.
- Do not use pans with jagged edges or drag pans across the Induction glass surface as this can scratch the glass.
- Do not use scourers or any other harsh abrasive cleaning agents to clean your cooktop, as these can scratch the ceramic glass.
- This appliance is intended to be used in household and domestic applications only.
- **WARNING:** The appliance and its accessible parts become hot during use.
- Care should be taken to avoid touching heating elements.
- Children less than 8 years of age shall be kept away unless continuously supervised.

SPECIFICATIONS

Cooking Hob	MINH59
Cooking Zones	4 Zones
Supply Voltage	220-240V~ 50Hz or 60Hz
Installed Electric Power	7400W
Product Size L×W×H(mm)	590X520X62
Building-in Dimensions A°B (mm)	560X490

Weight and Dimensions are approximate. Because we continually strive to improve our products we may change specifications and designs without prior notice.

PRODUCT INSTALLATION

Installation Area

Cut out the work surface according to the sizes shown in the drawing.

For the purpose of installation and use, a minimum of 5cm space shall be preserved around the hole. Be sure the thickness of the work surface is at least 30mm. Please select heat-resistant and insulated work surface material (Wood and similar fibrous or hygroscopic material shall not be used as work surface material unless impregnated) to avoid the electrical shock and larger deformation caused by the heat radiation from the hotplate. As shown below:

Note: The safety distance between the sides of the hob and the inner surfaces of the worktop should be at least 3mm.

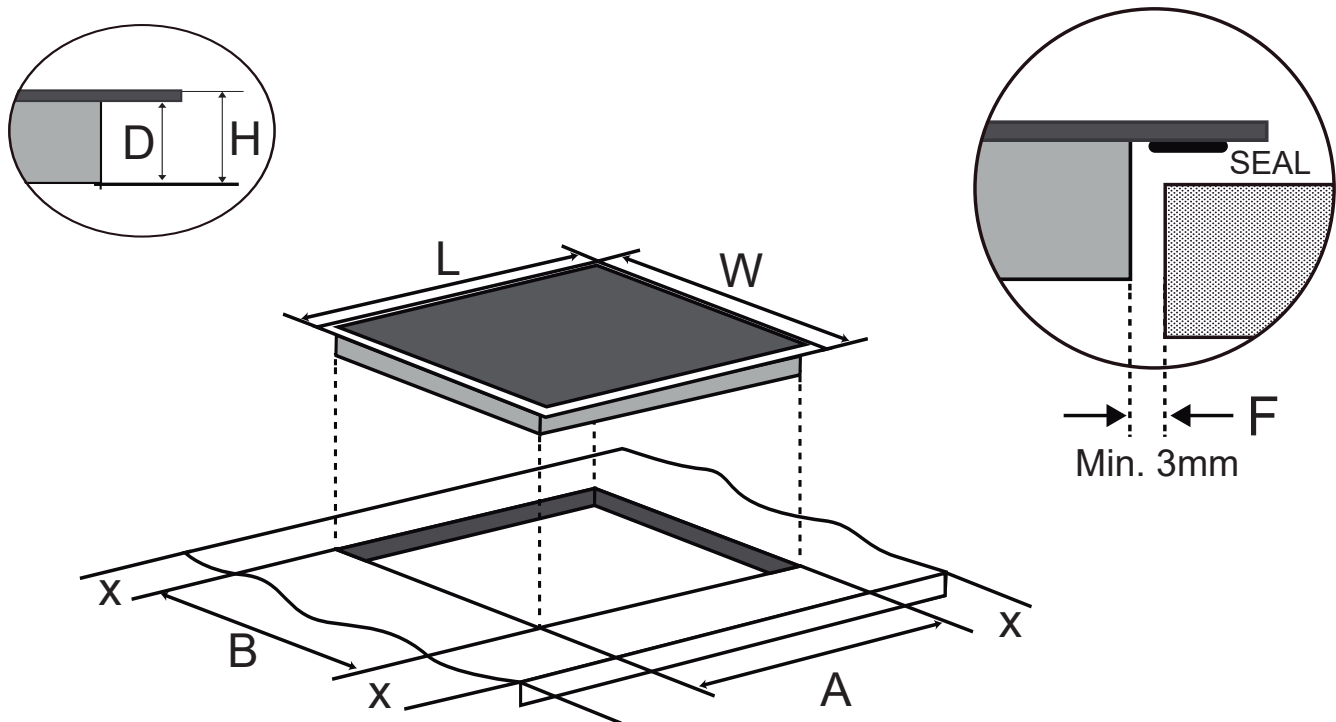

L(mm)	W(mm)	H(mm)	D(mm)	A(mm)	B(mm)	X(mm)	F(mm)
590	520	62	58	560±4	490±4	50 min	3 min

Under any circumstances, make sure the Induction cooker hob is well ventilated and the air inlet and outlet are not blocked. Ensure the Induction cooker hob is in good work state. As shown below.

Note: The safety distance between the hotplate and the hood/cupboard above the hotplate should be at least 650mm (refer to the installation instructions for hoods as the measurements may vary).

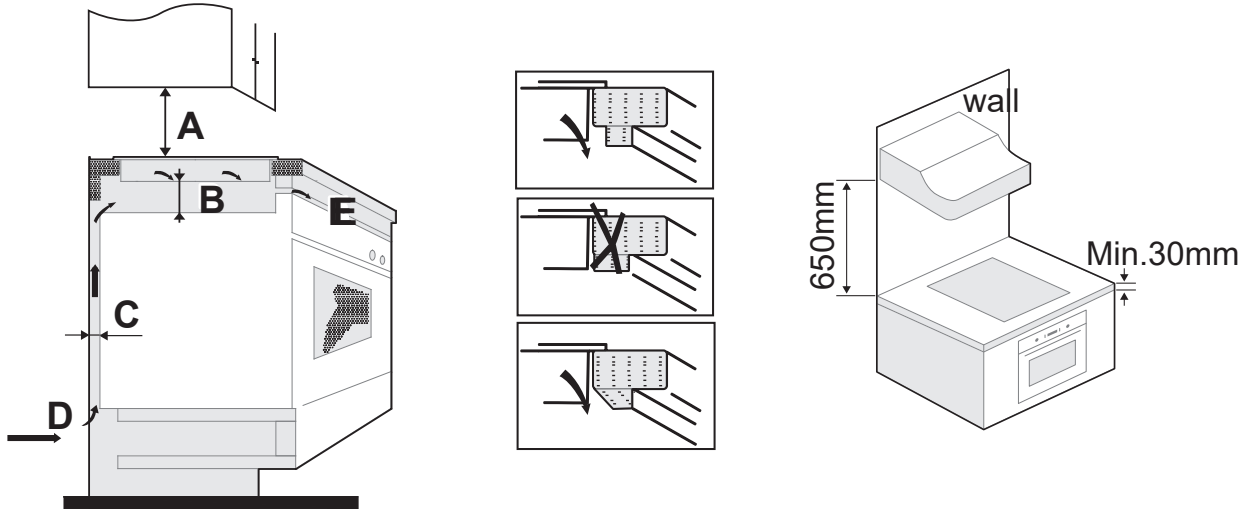



A(mm)	B(mm)	C(mm)	D	E
650	50 min	20 min	Air intake	Air exit 5mm

WARNING: Ensuring Adequate Ventilation

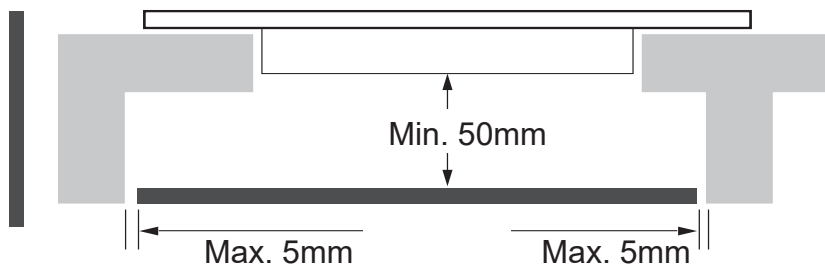
Make sure the induction hob is well ventilated and that air inlet and outlet are not blocked. In order to avoid accidental touch with the overheating bottom of the hob, or getting unexpected electric shock during working, it is necessary to put a wooden insert, fixed by screws, at a minimum distance of 50mm from the bottom of the hob. Follow the requirements below.



-  There are ventilation holes around outside of the hob. YOU MUST ensure these holes are not blocked by the worktop when you put the hob into position.
-  • Be aware that the glue that joins the plastic or wooden material to the furniture, has to be resist to a temperature not below 150°C, to avoid unsticking of the paneling.
-  • The rear wall, adjacent and surrounding surfaces must therefore be able to withstand a temperature of 90°C.

Before installing the hob, make sure that

- The work surface is square and level, and no structural members interfere with space requirements.
- The work surface is made of a heat-resistant and insulated material.
- If the hob is installed above an oven, the oven has a built-in cooling fan.
- The installation will comply with all clearance requirements and applicable standards and regulations.
- A suitable isolating switch providing full disconnection from the mains power supply is incorporated in the permanent wiring, mounted and positioned to comply with the local wiring rules and regulations.
- The isolating switch must be of an approved type and provide a 3 mm air gap contact separation in all poles (or in all active [phase] conductors if the local wiring rules allow for this variation of the requirements).
- The isolating switch will be easily accessible to the customer with the hob installed.
- You consult local building authorities and by-laws if in doubt regarding installation.
- You use heat-resistant and easy-to-clean finishes (such as ceramic tiles) for the wall surfaces surrounding the hob.

After installing the hob, make sure that

- The power supply cable is not accessible through cupboard doors or drawers.
- There is adequate flow of fresh air from outside the cabinetry to the base of the hob.
- If the hob is installed above a drawer or cupboard space, a thermal protection barrier is installed below the base of the hob.
- The isolating switch is easily accessible by the customer.

Cautions

- The induction hob must be installed by qualified personnel or technicians. We have professionals at your service. Please never conduct the operation by yourself.
- The Induction cooker hob shall not be mounted above cooling equipment, dishwashers and laundry appliances.
- The Induction cooker hob shall be installed such that better heat radiation can be ensured to enhance its reliability.
- The wall and induced heating zone above the work surface shall withstand heat.
- To avoid any damage, the sandwich layer and adhesive must be resistant to heat.
- A steam cleaner is not to be used.

Before Locating the Fixing Brackets

The unit should be placed on a stable, smooth surface (use the packaging). Do not apply force onto the hob.

Fix the hob into the work surface by screwing four brackets on the bottom of hob (see picture)

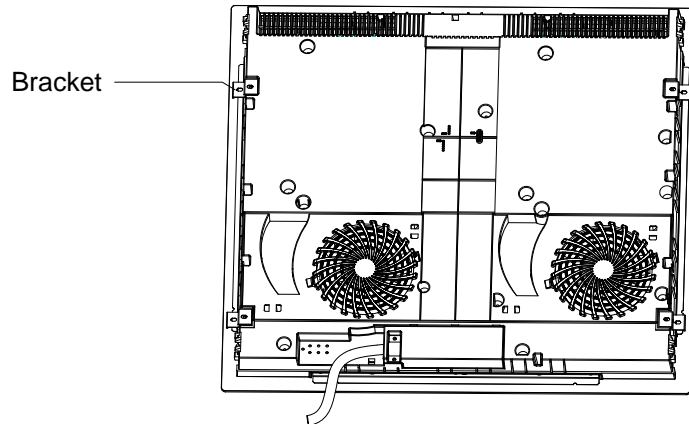

After installation adjust the bracket position to suit for different table top thickness.

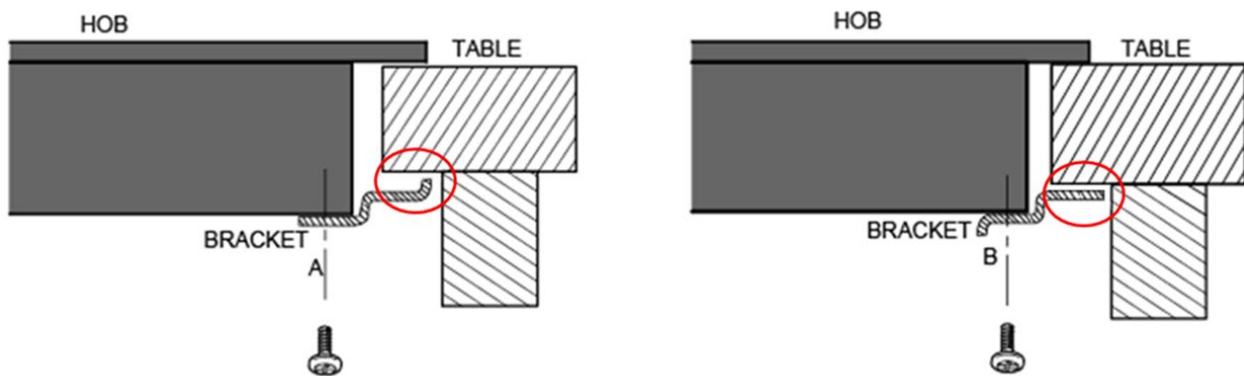

Under any circumstances, the brackets cannot touch with the inner surfaces of the worktop after installation (see picture).

Connecting the Hob to the Mains Power Supply



This hob must be connected to the mains power supply only by a suitably qualified person.

Before connecting the hob to the mains power supply, check that:

- Check with an electrician whether the domestic wiring system is suitable without alterations. Any alterations must only be made by a qualified electrician.
- The voltage corresponds to the value given in the rating plate
- The power supply cable sections can withstand the load specified on the rating plate. To connect the hob to the mains power supply, do not use adapters, reducers, or branching devices, as they can cause overheating and fire.
- The power supply cable must not touch any hot parts and must be positioned so that its temperature will not exceed 75°C at any point.

Connections according to the power supply are listed below:

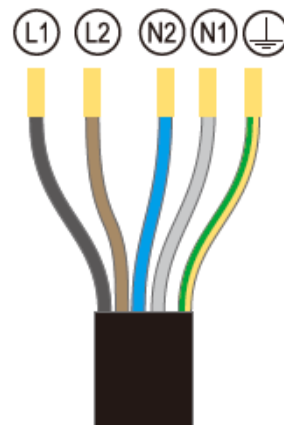
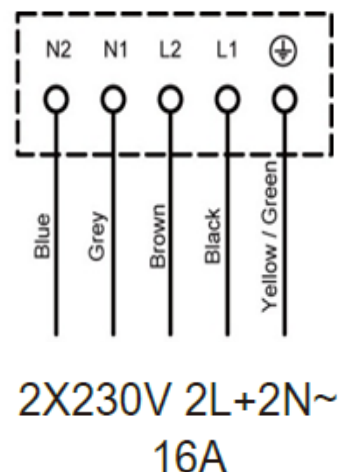
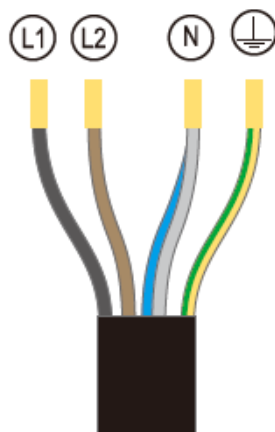
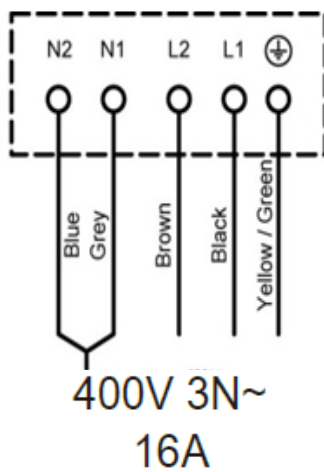
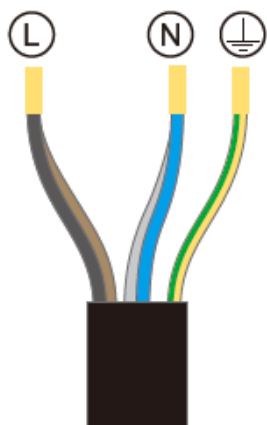
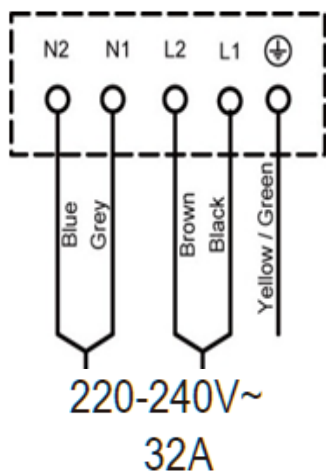

- If the cable is damaged or to be replaced, the operation must be carried out by after-sales agent with dedicated tools to avoid any accidents.
- The appliance should be hard wired directly to the mains and protected by a 32Amp fuse or circuit/breaker. An omni-polar circuit-breaker must be installed with a minimum opening of 3mm between contacts.
- A separate isolating switch should be accessible in case the appliance requires turning off before any work or maintenance is carried out on the hob.
- The installer must ensure that the correct electrical connection has been made and that it is compliant with safety regulations.
- The cable must not be bent or compressed.
- The cable must be checked regularly and replaced by authorised technicians.



The bottom surface and the power cord of the hob are not accessible after installation.

PRODUCT OVERVIEW

Top View

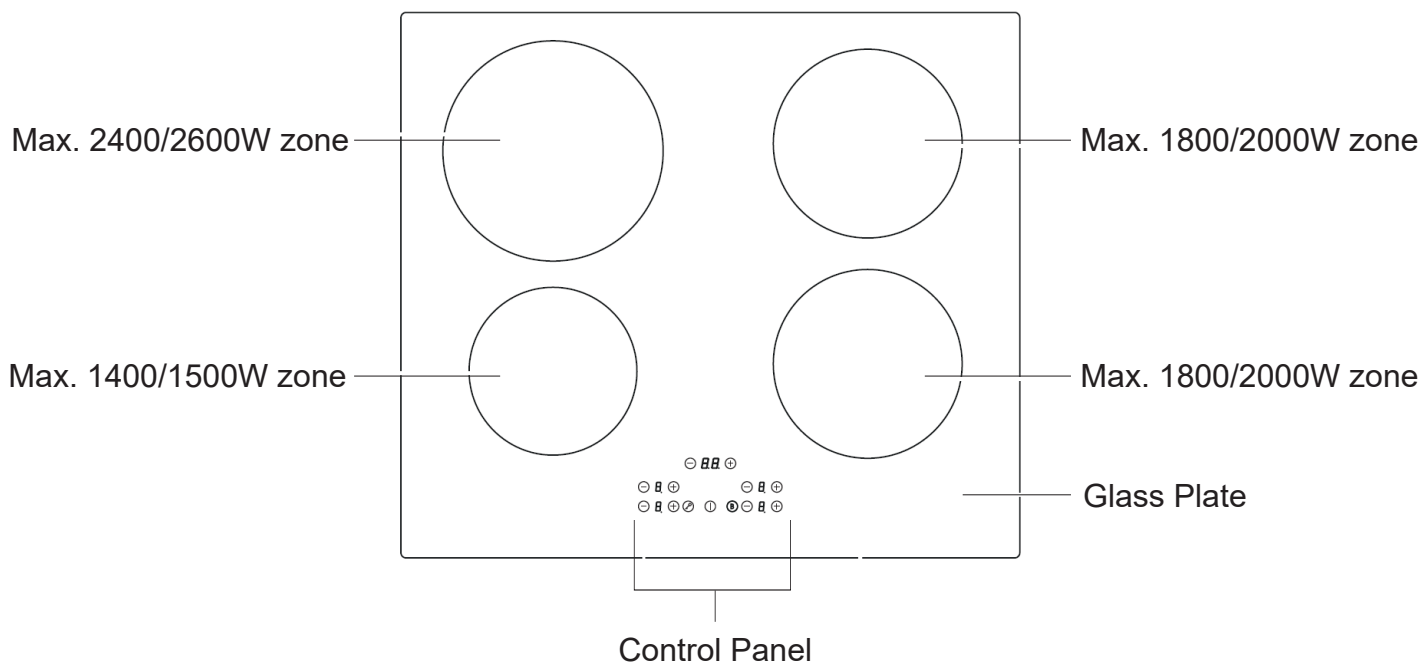

Control Panel

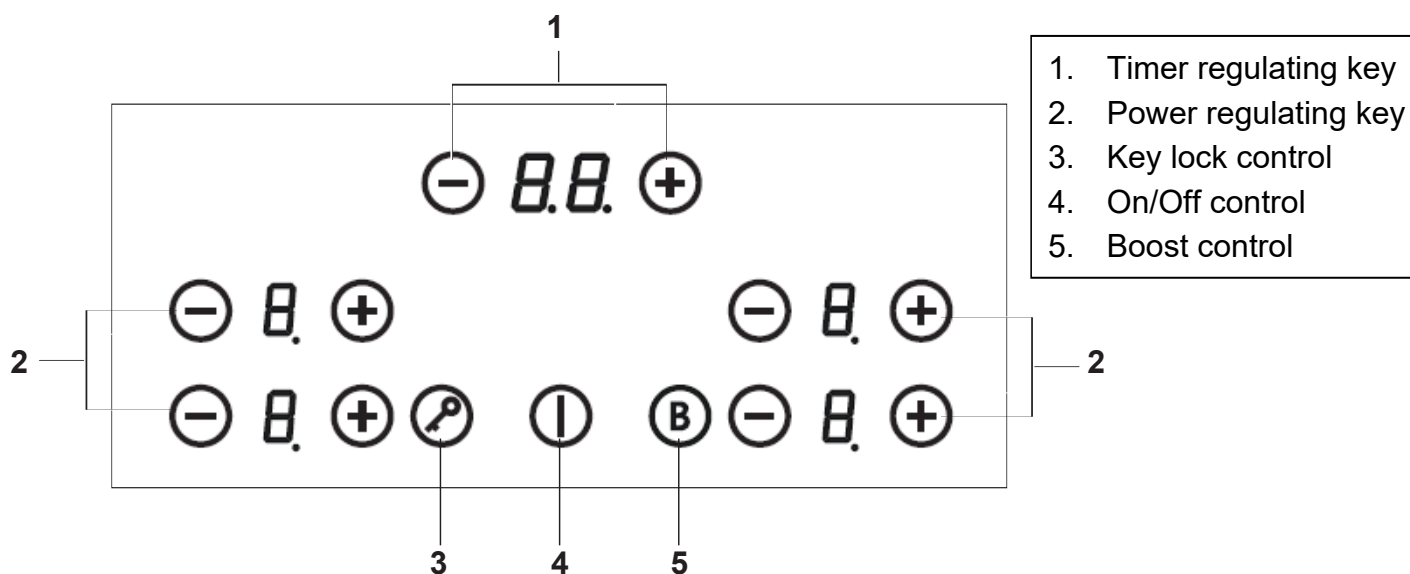

NOTE

All the pictures in this manual are for explanation purpose only. Any discrepancy between the real object and the illustration in the drawing shall be subject to the real subject.

Working Principle

Induction cooking is a safe, advanced, efficient, and economical cooking technology. It works by electromagnetic vibrations generating heat directly in the pan, rather than indirectly through heating the glass surface. The glass becomes hot only because the pan eventually warms it up.

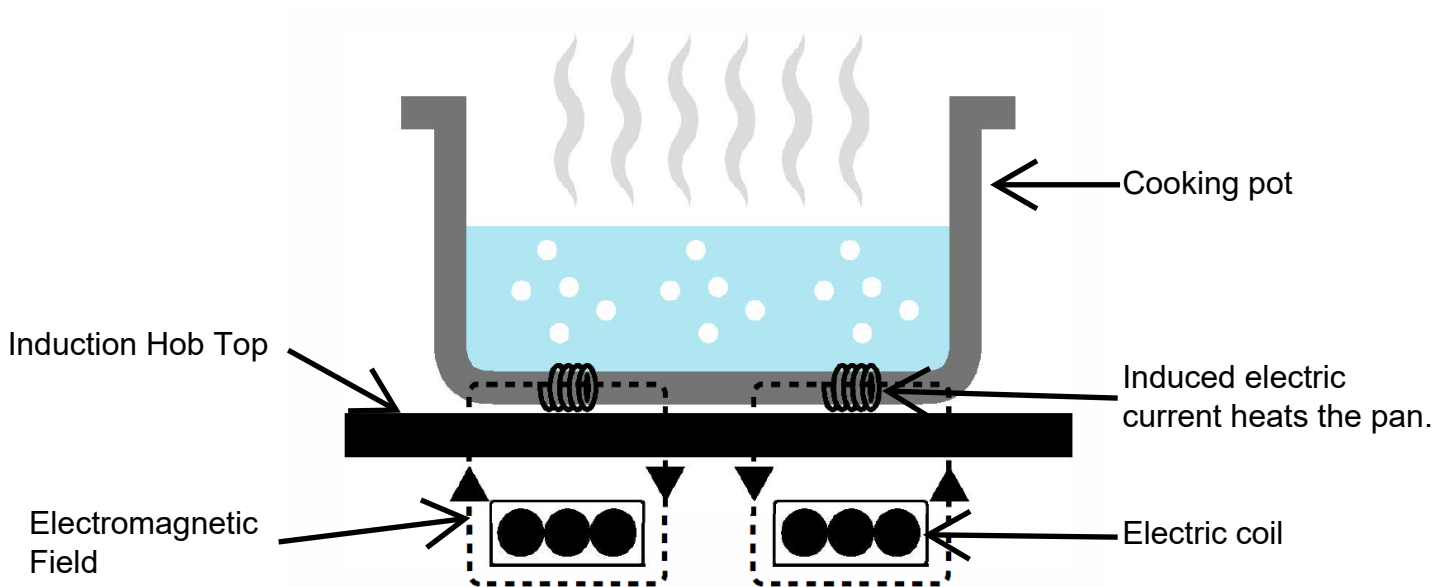

Before Using Your New Induction Hob

- Read this guide, taking special note of the 'Safety Warnings' section.
- Remove any protective film that may still be on your Induction hob.

OPERATION INSTRUCTIONS

Touch Controls

- The controls respond to touch, so you don't need to apply any pressure.
- Use the ball of your finger, not its tip.
- You will hear a beep each time a touch is registered.
- Make sure the controls are always clean, dry, and that there is no object (e.g. a utensil or a cloth) covering them. Even a thin film of water may make the controls difficult to operate.

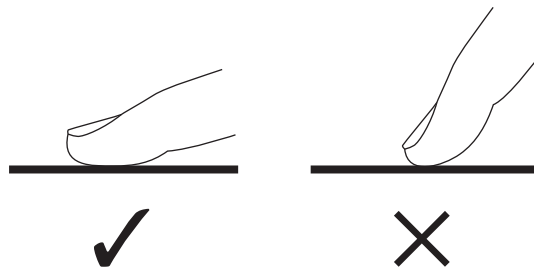

Choosing the Right Cookware



- Only use cookware with a base suitable for induction cooking. Look for the induction symbol on the packaging or on the bottom of the pan.

- You can check whether your cookware is suitable by carrying out a magnet test. Move a magnet towards the base of the pan. If it is attracted, the pan is suitable for induction.

- If you do not have a magnet:

1. Put some water in the pan you want to check.
2. If  does not flash in the display and the water is heating, the pan is suitable.

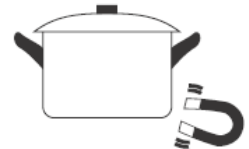

- Cookware made from the following materials is not suitable: pure stainless steel, aluminium or copper without a magnetic base, glass, wood, porcelain, ceramic, and earthenware.
- If the ferromagnetic part covers only partially the base of the pan, only the ferromagnetic area will heat up, the rest of the base may not heat up to a sufficient temperature for cooking.
- If the ferromagnetic area is not homogeneous, but presents others material such as aluminum this may affect the heating up and the pan detection.
- If the base of the pan is similar to the pictures below the pan may not be detected.



- Do not use cookware with jagged edges or a curved base.

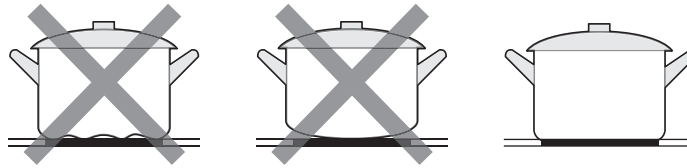

- Make sure that the base of your pan is smooth, sits flat against the glass, and is the same size as the cooking zone. Always centre your pan on the cooking zone.

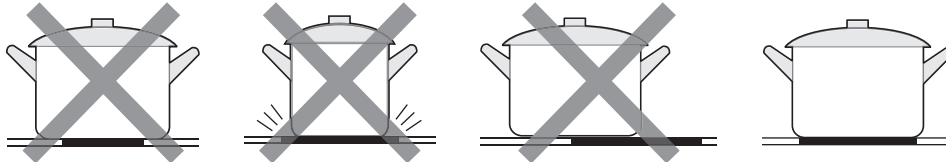

- Always lift pans off the Induction hob – do not slide, or they may scratch the glass.

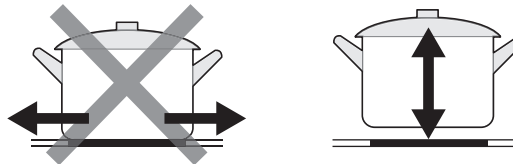

How to Use

1 Start cooking

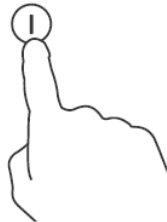
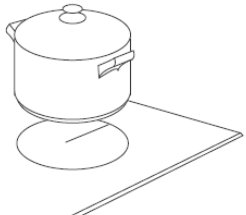
<p>Touch the ON/OFF control. After power on, the buzzer beeps once, all displays show “-” or “--”, indicating that the induction hob has entered the state of standby mode.</p>	
<p>Place a suitable pan on the cooking zone that you wish to use.</p> <ul style="list-style-type: none"> • Make sure the bottom of the pan and the surface of the cooking zone are clean and dry. 	

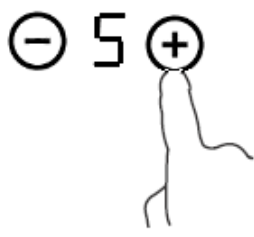
<p>Select a heat setting by touching the “-” or “+” control.</p> <ul style="list-style-type: none"> • If you don't choose a heat setting within 1 minute, the Induction hob will automatically switch off. You will need to start again at step 1. • You can modify the heat setting at any time during cooking 	
---	---



If the display flashes  alternately with the heat setting

This means that:

- You have not placed a pan on the correct cooking zone or,
- The pan you're using is not suitable for induction cooking or,
- The pan is too small or not properly centered on the cooking zone.

No heating takes place unless there is a suitable pan on the cooking zone. The display “” will automatically disappear after 1 minute if no suitable pan is placed on it.

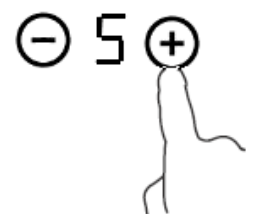
2 Finish cooking

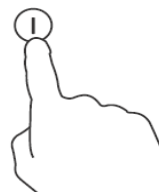
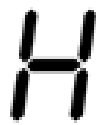
<p>Touching the heating zone selection control that you wish to switch off</p>	
<p>Turn the cooking zone off by scrolling down to “0” or touching “-” and “+” control together. Make sure the display shows “0”.</p>	
<p>Turn the whole cooktop off by touching the ON/OFF control.</p>	
<p>Beware of hot surfaces "H" will show which cooking zone is hot to touch. It will disappear when the surface has cooled down to a safe temperature. It can also be used as an energy saving function if you want to heat further pans, use the hotplate that is still hot.</p>	

3 Using the Boost function

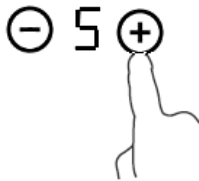
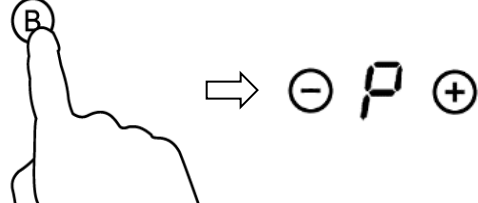
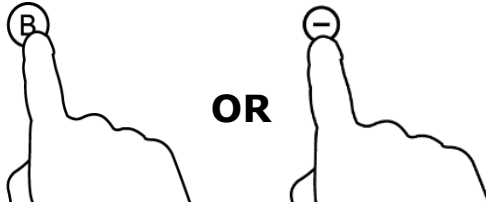
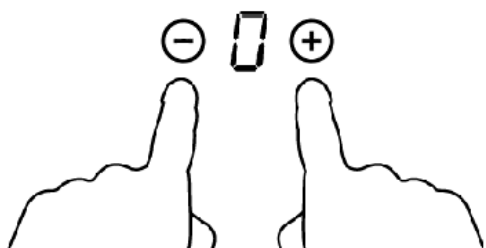

<p>Select the heating zone by touching the “-” or “+” control.</p>	
<p>Touching the boost control “B”, the zone indicator will show “P” and the power will be set to Max.</p>	
<p>Touching the “Boost” control or the “-” button to cancel the Boost function, then the cooking zone will revert to its original setting.</p>	
<p>Touching “-” and “+” control together. The cooking zone will be switched off and the boost function canceled automatically</p>	

- The function can work in any cooking zone.
- The cooking zone returns to its original setting after 5 minutes.
- If the original heat setting equals 0, it will return to 9 after 5 minutes.

4 Locking the Controls

- You can lock the controls to prevent unintended use (for example children accidentally turning the cooking zones on).
- When the controls are locked, all the controls except the ON/OFF control are disabled.

<p style="text-align: center;">To lock the controls</p>	
<p>Touch and hold the lock control for a while.</p>	<p>The timer indicator will show “Lo”</p>
<p style="text-align: center;">To unlock the controls</p>	
<p style="text-align: center;">Touch and hold the lock control for a while.</p>	

-  When the hob is in the lock mode, all the controls are disabled except the ON/OFF . You can always turn the induction hob off with the ON/OFF  control in an emergency, but you shall need to unlock the hob for any other operation.



5 Timer control

You can use the timer in two different ways:

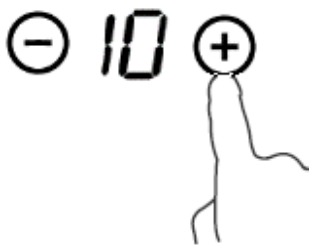
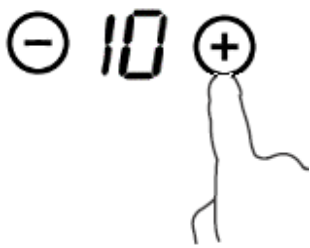
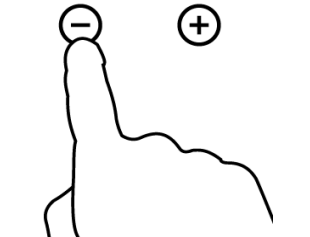
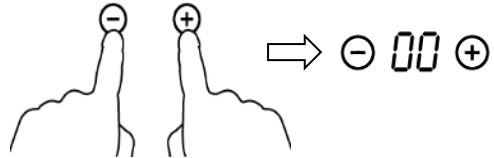

- You can use it as a minute minder. In this case, the timer will not turn any cooking zone off when the set time is up.
- You can set it to turn one or more cooking zones off after the set time is up. The timer can be set for a maximum of 99mins..

a) Using the Timer as a Minute Minder

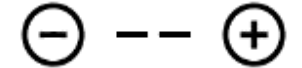
If you are not selecting any cooking zone

<p>Make sure the cooktop is turned on. Note: When using the minute minder at least one zone shall be active.</p>	
<p>Touch the controls of the timer. The minder indicator will start flashing and "10" will show in the timer display.</p>	
<p>Set the time by touching the "-" or "+" control of the timer Hint: Touch the "-" or "+" control of the timer once to decrease or increase by 1 minute. Touch and hold the "-" or "+" control of the timer to decrease or increase by 10 minutes.</p>	
<p>Touching the "-" and "+" together, the timer is cancelled, and the "00" will show in the minute display.</p>	
<p>When the time is set, it will begin to count down immediately. The display will show the remaining time and the timer indicator will flash for 5 seconds.</p>	
<p>Buzzer will beep for 30 seconds and the timer indicator shows "--" when the setting time finished.</p>	

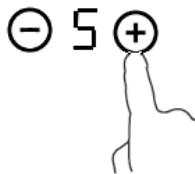
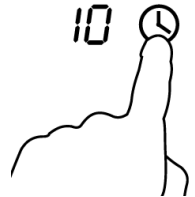
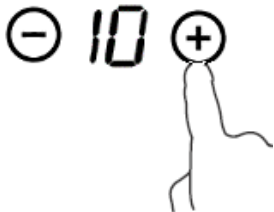
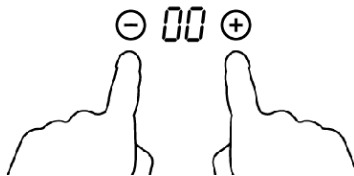
b) Setting the timer to turn one or more cooking zone off

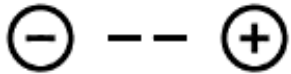
Setting a zone timer	
Touch the “-” or “+” of the corresponding cooking zone you want to set the timer for.	
Once you have selected the required zone touch the timer control, the minder indicator will start flashing and “10” will show in the timer display.	
Set the time by touching the “-” or “+” control of the timer Hint: Touch the “-” or “+” control of the timer once will decrease or increase by 1 minute. Touch and hold the “-” or “+” control of the timer will decrease or increase by 10 minutes.	
Touching the “-” and “+” together, the timer is cancelled, and the “00” will show in the minute display.	
When the time is set, it will begin to count down immediately. The display will show the remaining time and the timer indicator flash for 5 seconds. NOTE: The red dot next to power level indicator will illuminate indicating that zone is selected.	
When cooking timer expires, the corresponding cooking zone will be switched off automatically.	



Other cooking zone will keep operating if they are turned on previously.
The pictures shown above are for reference only, and the final product shall prevail.

set more than one zone:

When you set the time for several cooking zones simultaneously, decimal dots of the relevant cooking zones are on. The minute display shows the min. timer. The dot of the corresponding zone flashes.

⊖ 6.⊕

⊖ 3.⊕

⊖ 15 ⊕

(set to 15 minutes) (set to 45 minutes)

Once the countdown timer expires, the corresponding zone will switch off. Then it will show the new min. timer and the dot of corresponding zone will flash

⊖ H ⊕

⊖ 3.⊕

⊖ 30 ⊕

(set to 30 minutes)

6 Residual Heat Warning

When the hob has been operating for some time, there will be some residual heat. The letter "H" appears to warn you to keep away from it.

7 Default working times

Auto shut down is a safety protection function for your induction hob. It shut down automatically if ever you forget to turn off your cooking. The default working times for various power levels are shown in the below table:

Power level	1	2	3	4	5	6	7	8	9
Default working timer (hour)	8	8	8	4	4	4	2	2	2

When the pot is removed, the induction hob will stop heating immediately and the hob will automatically switch off after 2 minutes.



People with a heart pace maker should consult with their doctor before using this unit.

QUICK START GUIDE



Take care when frying as the oil and fat heat up very quickly, particularly if you're using Power Boost. At extremely high temperatures oil and fat will ignite spontaneously and this presents a serious fire risk.

Cooking Tips

- When food comes to the boil, reduce the temperature setting.
- Using a lid will reduce cooking times and save energy by retaining the heat.
- Minimize the amount of liquid or fat to reduce cooking times.
- Start cooking on a high setting and reduce the setting when the food has heated through.

Simmering, Cooking rice

- Simmering occurs below boiling point, at around 85°C, when bubbles are just rising occasionally to the surface of the cooking liquid. It is the key to delicious soups and tender stews because the flavours develop without overcooking the food. You should also cook egg-based and flour thickened sauces below boiling point.
- Some tasks, including cooking rice by the absorption method, may require a setting higher than the lowest setting to ensure the food is cooked properly in the time recommended.

Searing Steak

To cook juicy flavorsome steaks:

1. Stand the meat at room temperature for about 20 minutes before cooking.
2. Heat up a heavy-based frying pan.
3. Brush both sides of the steak with oil. Drizzle a small amount of oil into the hot pan and then lower the meat onto the hot pan.
4. Turn the steak only once during cooking. The exact cooking time will depend on the thickness of the steak and how cooked you want it. Times may vary from about 2 – 8 minutes per side. Press the steak to gauge how cooked it is – the firmer it feels the more 'well done' it will be.
5. Leave the steak to rest on a warm plate for a few minutes to allow it to relax and become tender before serving.

For Stir-frying

1. Choose a compatible flat-based wok or a large frying pan.
2. Have all the ingredients and equipment ready. Stir-frying should be quick. If cooking large quantities, cook the food in several smaller batches.
3. Preheat the pan briefly and add two tablespoons of oil.
4. Cook any meat first, put it aside and keep warm.
5. Stir-fry the vegetables. When they are hot but still crisp, turn the cooking zone to a lower setting, return the meat to the pan and add your sauce.
6. Stir the ingredients gently to make sure they are heated through.
7. Serve immediately.

Detection of Small Articles

When an unsuitable size or non-magnetic pan (e.g. aluminium), or some other small item (e.g. knife, fork, key) has been left on the hob, the hob will automatically go on to standby in 1 minute. The fan will keep cooling down the induction hob for a further 1 minute.

Heat Settings

The settings below are guidelines only. The exact setting will depend on several factors, including your cookware and the amount you are cooking. Experiment with the Induction hob to find the settings that best suit you.

Heat setting	Suitability
1 - 2	<ul style="list-style-type: none">• delicate warming for small amounts of food• melting chocolate, butter, and foods that burn quickly• gentle simmering• slow warming
3 - 4	<ul style="list-style-type: none">• reheating• rapid simmering• cooking rice
5 - 6	<ul style="list-style-type: none">• pancakes
7 - 8	<ul style="list-style-type: none">• sautéing• cooking pasta
9	<ul style="list-style-type: none">• stir-frying• searing• bringing soup to the boil• boiling water

CLEANING AND MAINTENANCE

What?	How?	Important!
<p>Everyday soiling on glass (fingerprints, marks, stains left by food or non-sugary spillovers on the glass).</p>	<ul style="list-style-type: none"> • Switch the power to the cooktop off. • Apply a cooktop cleaner while the glass is still warm (but not hot!) • Rinse and wipe dry with a clean cloth or paper towel. • Switch the power to the cooktop back on. 	<ul style="list-style-type: none"> • When the power to the cooktop is switched off, there will be no 'hot surface' indication but the cooking zone may still be hot! Take extreme care. • Heavy-duty scourers, some nylon scourers and harsh/abrasive cleaning agents may scratch the glass. Always read the label to check if your cleaner or scourer is suitable. • Never leave cleaning residue on the cooktop: the glass may become stained.
<p>Boilovers, melts, and hot sugary spills on the glass.</p>	<p>Remove these immediately with a fish slice, palette knife or razor blade scraper suitable for Ceramic glass cooktops, but beware of hot cooking zone surfaces:</p> <ul style="list-style-type: none"> • Switch the power to the cooktop off at the wall. • Hold the blade or utensil at a 30° angle and scrape the soiling or spill to a cool area of the cooktop. • Clean the soiling or spill up with a dish cloth or paper towel. • Follow steps 2 to 4 for 'Everyday soiling on glass' above. 	<ul style="list-style-type: none"> • Remove stains left by melts and sugary food or spillovers as soon as possible. If left to cool on the glass, they may be difficult to remove or even permanently damage the glass surface. • Cut hazard: when the safety cover is retracted, the blade in a scraper is razor-sharp. Use with extreme care and always store safely and out of reach of children.
<p>Spillovers on the touch controls.</p>	<ul style="list-style-type: none"> • Switch the power to the cooktop off. • Soak up the spill. • Wipe the touch control area with a clean damp sponge or cloth. • Wipe the area completely dry with a paper towel. • Switch the power to the cooktop back on. 	<ul style="list-style-type: none"> • The cooktop may beep and turn itself off, and the touch controls may not function while there is liquid on them. Make sure you wipe the touch control area dry before turning the cooktop back on.

TROUBLESHOOTING

Operation of your appliance can lead to errors and malfunctions. The following tables contain possible causes and notes for resolving an error message or malfunction. It is recommended to read the tables carefully below in order to save your time and money that may cost for calling to the service center.

Problem	Possible causes	What to do
The cooktop cannot be turned on.	No power.	Make sure the induction hob is connected to the power supply and that it is switched on. Check whether there is a power outage in your home or area. If you've checked everything and the problem persists, call a qualified technician.
The touch controls are unresponsive.	The controls are locked.	Unlock the controls. See section 'Using your Induction cooktop' for instructions.
The touch controls are difficult to operate.	There may be a slight film of water over the controls or you may be using the tip of your finger when touching the controls.	Make sure the touch control area is dry and use the ball of your finger when touching the controls.
The glass is being scratched.	Rough-edged cookware. Unsuitable, abrasive scourer or cleaning products being used.	Use cookware with flat and smooth bases. See 'Choosing the right cookware'. See 'CLEANING AND MAINTENANCE'.
Some pans make crackling or clicking noises.	This may be caused by the construction of your cookware (layers of different metals vibrating differently).	This is normal for cookware and does not indicate a fault.

Problem	Possible causes	What to do
The induction hob makes a low humming noise when used on a high heat setting.	This is caused by the technology of induction cooking.	This is normal, but the noise should quieten down or disappear completely when you decrease the heat setting.
Fan noise coming from the induction hob.	A cooling fan built into your induction hob has come on to prevent the electronics from overheating. It may continue to run even after you've turned the induction hob off.	This is normal and needs no action. Do not switch the power to the induction hob off at the wall while the fan is running.
Pans do not become hot and E appears in the display.	The induction hob cannot detect the pan because it is not suitable for induction cooking. The induction hob cannot detect the pan because it is too small for the cooking zone or not properly centred on it.	Use cookware suitable for induction cooking. See section 'Choosing the right cookware'. Centre the pan and make sure that its base matches the size of the cooking zone.
The induction hob or a cooking zone has turned itself off unexpectedly, a tone sounds and an error code is displayed (typically alternating with one or two digits in the cooking timer display).	Technical fault.	Please note down the error letters and numbers, switch the power to the induction hob off at the wall, and contact a qualified technician.

Failure Display and Inspection

The Induction hob is equipped with a self diagnostic function. With this test the technician is able to check the function of several components without disassembling or dismantling the hob from the working surface.

Troubleshooting

1) Failure code occur during customer using & Solution;

Failure code	Problem	Solution
No Auto-Recovery		
E1	Ceramic plate temperature sensor failure--open circuit.	Check the connection or replace the ceramic plate temperature sensor.
E2	Ceramic plate temperature sensor failure- -short circuit.	
Eb	Ceramic plate temperature sensor failure.	
E3	High temperature of ceramic plate sensor.	Wait for the temperature of ceramic plate return to normal. Touch "ON/OFF" button to restart unit.
E4	Temperature sensor of the IGBT failure--open circuit.	Replace the display board.
E5	Temperature sensor of the IGBT failure--short circuit.	
E6	High temperature of IGBT.	Wait for the temperature of IGBT return to normal. Touch "ON/OFF" button to restart unit. Check whether the fan runs smoothly; if not , replace the fan.
E7	Supply voltage is below the rated voltage.	Please inspect whether power supply is normal. Power on after the power supply is normal.
E8	Supply voltage is above the rated voltage.	
U1	Communication error.	Reinsert the connection between the display board and the power board. Replace the power board or the display board.

2) Specific Failure & Solution

: U`i fY	DfcVYa`	Gc`i h`cb`5`	Gc`i h`cb`6`
The LED does not come on when unit is plugged in.	No power supplied.	Check to see if plug is secured tightly in outlet and that outlet is working.	
	The accessorial power board and the display board connected failure.	Check the connection.	
	The accessorial power board is damaged.	Replace the accessorial power board.	
	The display board is damaged.	Replace the display board.	
Some buttons can't work, or the LED display is not normal.	The display board is damaged.	Replace the display board.	
The Cooking Mode Indicator comes on, but heating does not start.	High temperature of the hob.	Ambient temperature may be too high. Air Intake or Air Vent may be blocked.	
	There is something wrong with the fan.	Check whether the fan runs smoothly; if not , replace the fan.	
	The power board is damaged.	Replace the power board.	
Heating stops suddenly during operation and the display flashes "u".	Pan Type is wrong.	Use the proper pot (refer to the instruction manual.)	Pan detection circuit is damaged, replace the power board.
	Pot diameter is too small.		
	Cooker has overheated;	Unit is overheated. Wait for temperature to return to normal. Push "ON/OFF" button to restart unit.	

: Uj'i fY'	DfcVYa'	Gc`i Hcb'5'	Gc`i Hcb'6'
Heating zones of the same side (Such as the first and the second zone) would display "u" .	The power board and the display board connected failure;	Check the connection.	
	The display board of communicate part is damaged.	Replace the display board.	
	The Main board is damaged.	Replace the display board.	
Fan motor sounds abnormal.	The fan motor is damaged.	Replace the fan.	

The above are the judgment and inspection of common failures.

Please do not disassemble the unit by yourself to avoid any dangers and damages to the induction hob.

DISPOSAL AND RECYCLING

Important Instructions for Environment

This appliance is labeled in compliance with European directive 2012/19/EU for Waste Electrical and Electronic Equipment (WEEE). By ensuring that this appliance is disposed of correctly, you will help prevent any possible damage to the environment and to human health, which might otherwise be caused if it were disposed of in the wrong way.

This symbol indicates that this product shall not be disposed with other household wastes at the end of its service life. Used device must be returned to official collection point for recycling of electrical electronic devices. To find these collection systems please contact to your local authorities or retailer where the product was purchased. Each household performs important role in recovering and recycling of old appliance. Appropriate disposal of used appliance helps prevent potential negative consequences for the environment and human health.



Here For You

After-sales assistance

If you continue to experience problems with your appliance, please call the Montpellier customer service helpline on: **01759 487839**

D`YUgY` \ Uj Y` U` ` nci f` dfcXi Wi XYHJ`g` Uj Uj`UV`Yž`]bWi X]b[` h Y` a cXY` bi a VYfž` gYf]U` bi a VYfž` cf][]bU` gUYg`]bj c]W` fWYUf` mi gl ck]b[` a cXY` bi a VYfž`XUH` cZ di fW UgY` UbX` nci f` fYHJ` Yfjg` XYHJ` g` VYZ` fY` fY[]ghYf]b[`UZU` `H`

The service call cannot progress without this information.

Your 2 year Manufacturer's guarantee

THIS DOES NOT AFFECT YOUR STATUTORY RIGHTS.

Your new Montpellier appliance carries a free guarantee which protects you against the cost of repairs during the first 24 months from date of purchase provided that:

Any claim is accompanied by evidence of the model reference, model serial number and proof of purchase, such as a Sales Receipt, showing that the appliance was purchased within the 24 months prior to the date of claim.

What is not covered under the Guarantee

- Any appliance not correctly installed and operated in accordance with the manufacturer's instructions
- Any appliance that is used for anything other than domestic purposes.
Any defect caused by accident, misuse, unauthorised modification or inexperienced repair.
- Cost of Call-out where a fault cannot be found with the appliance.
Cost of Call-out for work covering routine maintenance, such as, but not exclusively, cleaning of filters or defrosting.
- Cost of Call-out for work required to correct the alignment of doors following door reversal procedures carried out by you.
Use of the appliance by anyone other than the Householder.
Use in any commercial environment.
- Consumable items, such as, but not exclusively, fuses in plugs, bulbs and breakable items which require routine replacement.
Repair costs incurred that have not been authorised by Montpellier service and/or carried out by a non-approved Montpellier engineer.
- Montpellier Appliances do not accept claims for consequential loss, rusting, corroding, delivery damage or scratches.

YOUR GUARANTEE IS VALID ONLY IN THE UK & REPUBLIC OF IRELAND

To register your appliance simply complete the card in your appliance pack and return it with a stamp affixed. Alternatively you can register online at www.montpellier-appliances.com/support

SERVICE HELP-LINE

Should your appliance develop a fault, please call the Montpellier customer service helpline on:

01759 487839

D`YUgY`fYa Ya VYf`hc \ Uj Y`U` `nci f`dfcXi WiXYHJ`g`Uj Uj`UV`Yž`]bWi X]b[`h Y`a cXY`bi a VYfž` gYf]U`bi a VYfž`XUH`cZdi fW UgY`UbX`nci f` fYHJ` Yfjg` XYHJ` g` VYZ` fY` fY[]ghYf]b[`UZU` `H`

Montpellier Domestic Appliances Ltd.

Unit 1, Tewkesbury Retail Park, Northway Lane,
Tewkesbury, Gloucestershire GL20 8JU

www.montpellier-appliances.com



The symbol on the product or on its packaging indicates that this product may not be treated as household waste. Instead it shall be handed over to the applicable collection point for the recycling of electrical and electronic equipment. By ensuring this product is disposed of correctly, you will help prevent potential negative consequences for the environment and human health, which could otherwise be caused by inappropriate waste handling of this product. For more detailed information about recycling of this product, please contact your local city office, your household waste disposal service or the shop where you purchased the product.